



TM/TMC-4200CL Series Progressive Scan Cameras

Operation Manual

Notice

The material contained in this manual consists of information that is proprietary to JAI PULNiX, Inc., and may only be used by the purchasers of the product. JAI PULNiX, Inc. makes no warranty for the use of its product and assumes no responsibility for any errors which may appear or for damages resulting from the use of the information contained herein. JAI PULNiX, Inc. reserves the right to make changes without notice.

Microsoft, Windows XP, Windows 2000, Windows 98, Windows 95, Windows NT, and Windows Explorer are either registered trademarks or trademarks of Microsoft Corporation in the United States and/or other countries.

Warranty

All of our solid-state cameras sold in North America have a full three-year warranty. Those sold elsewhere have a full one-year warranty. If any such product proves defective during the warranty period, JAI PULNiX, Inc. will repair the defective product without charge for parts and labor or will provide a replacement in exchange for the defective product. This warranty shall not apply to any damage, defect or failure caused by improper use or inadequate maintenance.

Certifications

CE Compliance

The TM-4200CL series of cameras has been certified to conform to the requirements of Council Directive 89/336/EC for electromagnetic compatibility and to comply with the following European Standards:

Immunity: EN50082-2/1997

Emissions: CISPR22: 1997/EN55011: 1998 Class B

All PULNiX products bearing the CE mark have been declared to be in conformance with the applicable EEC Council Directives. However, certain factory-installed options or customer-requested modifications may compromise electromagnetic compatibility and affect CE compliance. Please note that the use of interconnect cables that are not properly grounded and shielded may affect CE compliance.

Contact PULNiX Applications Engineering Department for further information regarding CE compliance.

FCC

This equipment has been tested and found to comply with the limits for a Class A digital device, pursuant to Part 15 of the FCC Rules. These limits are designed to provide reasonable protection against harmful interference when the equipment is operated in a commercial environment. This equipment generates, uses and can radiate radio frequency energy and, if not installed and used in accordance with the instruction manual, may cause harmful interference to radio communications. Operation of this equipment in a residential area may cause harmful interference, in which case the user will be required to correct the interference at his own expense.

WARNING

Changes or modifications to this unit not expressly approved by the party responsible for FCC compliance could void the user's authority to operate the equipment.

TM-4200CL Operation Manual

JAI PULNiX, Inc.

625 River Oaks Parkway

San Jose, CA 95134

Tel:(408) 383-0300

Tel:(800) 445-5444

Fax:(408) 383-0301

E-mail: pulnix@pulnix.com

www.jaipulnix.com



Table of Contents

1	Software Use and Installation Introduction	1
1.1	Software Installation	1
1.1.1	Before Installing Dual-Tap AccuPiXEL Series Camera-Control Software	1
1.1.2	Installing the Software	2
1.1.3	Installing the Camera Link API DLL (clserXXX.dll)	3
1.1.4	Running Dual Tap AccuPiXEL	3
1.1.5	Uninstalling the Software	4
2	TM/TMC-4200CL Camera	6
3	Graphical User Interface	7
3.1	GUI Features	7
3.2	Using the CamLink Mode	8
3.2.1	GigE Mode	8
3.3	Operating The Control Software	9
3.3.1	Check Current Camera Setting	9
3.3.2	Exposure Control	9
3.3.3	Gain Control	12
3.3.4	Offset Voltage	12
3.3.5	Video Depth	13
3.3.6	Image Pre-Processing	13
3.3.7	Ctrl Signals	13
3.3.8	Trigger	14
3.3.9	LUT (Look-Up Table)	14
3.3.10	Report Section	16
3.3.11	Main Menu: “Option”	16
3.3.12	EEPROM	17
3.3.13	Main Menu “Connectivity”	18
3.3.14	Main Menu “About”	18
3.3.15	Exit	18
4	Hardware Introduction	19
4.1	Product Description	19
4.2	Features	20
4.3	System Configuration	21
5	Installation	22
5.1	Getting Started	22
5.1.1	Unpacking Instructions	22
5.1.2	Components List	22
5.1.3	Accessories and Options	22
5.2	Camera Setup	22
5.2.1	Heat Dissipation	22
5.2.2	Connector Pin Configurations	23
5.2.3	Camera Link Cable	25
5.2.4	Power Supplies and Power Cable Setup	25
5.2.5	Attaching the Analog Video Output	27
5.2.6	Attaching the Camera Lens	27

6	Functions and Operations	28
6.1	Camera Rear Pane	28
6.1.1	Digital I/O Connector (Camera Link)	28
6.1.2	Analog Output Connector	28
6.1.3	Power and External Sync Connector	28
6.2	Sensor Layer and Timing	29
6.3	Scan Area	31
6.3.1	Preset Scan Area	31
6.3.2	Programmable Scan Area	32
6.3.3	Full Scan Area 2x2 Binning	33
6.3.4	Sub-sampling Digital Zoom	34
6.4	Electronic Shutter	38
6.4.1	Preset Shutter	38
6.4.2	Programmable Exposure-Continuous Mode	38
6.4.3	Asynchronous No Shutter Mode	38
6.4.4	Asynchronous Programmable Exposure Mode	39
6.4.5	Pulse Width Control Mode	40
6.4.6	Particle Imaging Velocimetry Fixed Exposure Mode	41
6.4.7	PWC PIV Mode	42
6.5	Dynamic Range Control	44
6.5.1	Programmable Look-Up Table (LUT) and Knee Control	45
6.6	External Sync and Pixel Locking	46
7	Serial Communication Kit	47
7.1	Serial Communication Kit	47
7.2	TM-4200CL Command List	48
8	Problems and Solutions	54
8.0.1	Symptom: No Video	54
8.0.2	Symptom: Dark Video	54
8.0.3	Symptom: Non-synchronized Video	54
8.1	Information and Support Resources	55
9	Appendix	56
9.1	Specifications	56
9.1.1	TM-4200CL Physical Dimensions	57
9.1.2	Spectral Response	57

List of Figures

FIGURE 1.	Setup installs Dual Tap AccuPIXel v 2.5.0	2
FIGURE 2.	AccuPIXel Setup screen	3
FIGURE 3.	Follow the installation directions	3
FIGURE 4.	The screen grabber has an essential .dll file.	4
FIGURE 5.	“Add or Remove Programs” utility uninstalls older software.	5
FIGURE 6.	Back of the TM/TMC 4200CL	6
FIGURE 7.	Main DualTap AccuPiXEL Window	7
FIGURE 8.	Setting up CamLink	8
FIGURE 9.	Choose the desired frame driver .dll	8
FIGURE 10.	An error message appears if the .dll application is missing.	8
FIGURE 11.	The report frame is near the bottom of the window.	9
FIGURE 12.	Continuous mode operates the shutter from the camera settings.	9
FIGURE 13.	Trigger mode uses a manual or sensor command to operate the shutter.	10
FIGURE 14.	To use Programmable shutter speed, select Programmable:	10
FIGURE 15.	The Scan Area drop down box.	11
FIGURE 16.	Enter the starting line number for a programmable scan.	11
FIGURE 17.	Click the Apply button after programming the scan.	11
FIGURE 18.	Gain is being set if the R Auto Gain box appears checked.	12
FIGURE 19.	R Auto Offset box is checked only while the camera sets the command.	12
FIGURE 20.	Click the corresponding option button to set the tap.	13
FIGURE 21.	Click the option button to select Video Depth.	13
FIGURE 22.	Checking “Enable Blemish Compensation” activates Image Pre-Processing.	13
FIGURE 23.	Set “Ctrl Signal” by clicking the option button matching your cabling.	13
FIGURE 24.	Set “Trigger” by clicking the desired option button.	14
FIGURE 25.	Set “Positive” or “Negative” LUT.	14
FIGURE 26.	Table drop down menu:	14
FIGURE 27.	Gamma.45 imitates human eye sensitivity when creating an image.	15
FIGURE 28.	The knee setting activates when “Send Knees” is clicked.	15
FIGURE 29.	The report frame shows the recent camera actions.	16
FIGURE 30.	A table helps users understand the report screen.	16
FIGURE 31.	Use the “Option” menu to access the test pattern.	17
FIGURE 32.	Use the “Option” menu to access the test pattern.	17
FIGURE 33.	Use the “Connectivity” menu to set buffer size.	18
FIGURE 34.	The “About” menu provides hardware and software information.	18
FIGURE 35.	CL (Camera Link) System Configuration	21
FIGURE 36.	Hirose Connector	23
FIGURE 37.	26-pin Camera Link Connector.	24
FIGURE 38.	BNC Connector.	24
FIGURE 39.	3M Camera Link Cable	25
FIGURE 40.	12P-02S Interface Cable (optional)	26
FIGURE 41.	12P-02S Interface Cable Pin Out	26
FIGURE 42.	Camera Connectors	28
FIGURE 43.	Digital Video Output	29
FIGURE 44.	Camera Timing Chart	30
FIGURE 45.	Digital Data Output Order for Configuration	30
FIGURE 46.	Field Video Timing--Continuous Mode	31
FIGURE 47.	Bayer 1	33
FIGURE 48.	Bayer 2	33
FIGURE 49.	2x2 Binning	34
FIGURE 50.	Sub-sampling Digital Zoom	35
FIGURE 51.	Sub-sampling Digital Zoom 2x	35

FIGURE 52.	Sub-sampling Digital Zoom 3x	.36
FIGURE 53.	Sub-sampling Digital Zoom 4x	.37
FIGURE 54.	External Trigger Timing.	.39
FIGURE 55.	Asynchronous Programmable External Trigger	.40
FIGURE 56.	Pulse Width Control Trigger	.41
FIGURE 57.	PIV Exposure Timing Table	.41
FIGURE 58.	PWC PIV Timing Table.	.42
FIGURE 59.	Output and Blooming	.44
FIGURE 60.	Physical Dimensions	.57
FIGURE 61.	Spectral Response	.57

List of Tables

TABLE 1.	12-Pin Connector	23
TABLE 2.	Connector and Pin-out Configurations	24
TABLE 3.	Scan Area Start Points	37
TABLE 4.	Electronic Preset Shutter	38
TABLE 5.	Timing Chart	42
TABLE 6.	Asynchronous Mode Chart	44
TABLE 7.	TM-4200CL Command List	48
TABLE 8.	TM-4200CL Command Response Table	51
TABLE 9.	TM-4200CL Camera Specifications Table	56

Dual-Tap TM-4200CL AccuPiXEL Series Camera-Control Software

Operation Manual



TM-4200CL series.

1 Software Use and Installation Introduction

The Dual-Tap AccuPiXEL series cameras are high-resolution, progressive scan cameras with JAI PULNiX-proprietary LUT control and other excellent features. The software for these cameras was developed to function as standard software for the entire Dual-Tap AccuPiXEL series, and can open either the RS-232 serial port (COM) or Camera Link. Camera Link users must physically install the Camera Link frame grabber board into the PC. They must also install the Camera Link API (clserXXX.dll) software. These cameras are specially designed to capture images in progressive scan (non-interlace) format, producing a full frame of electronic shutter images, as well as normal images.

Although this software works with all AccuPiXEL cameras, the interface for the TM-4200CL series appears different from other cameras compatible with this same software, and has various capabilities, depending on the camera model the software is accessing. The TM-4200CL series software is therefore, specifically documented in this section

1.1 Software Installation

Following are the instructions to install the Dual-Tap AccuPiXEL series camera-control software on a PC.

1.1.1 Before Installing the Dual-Tap AccuPiXEL Series Camera-Control Software

Please note the following requirements.

- Your computer must be running Microsoft Windows NT 4.0, Windows 2000, or Windows XP.
- The software requires one available communication port that is not in conflict with other peripherals such as the mouse or modem.
- Installation of the software requires 2.4 MB of free space in your PC hard disk.

1.1.2 Installing the Software

To install the Dual-Tap AccuPiXEL series camera-control software, obtain the software from the JAI web site and run "Setup.exe." The installer will direct you to install the application code.

If dual tap software is already installed on your computer, uninstall the software using the steps in the Uninstall section.

Note: The link to the frame grabber must be configured after the new software installation. The program asks for the location.

1. To obtain the Dual Tap software visit the JAI PULNiX web site at <http://www.jaipulnix.com>
2. Click the Support link
3. Click the Software Downloads link under the Customer Support menu
4. Select the camera model number by clicking in the option button.
5. Select either *Open* or *Save* on the install dialog box

Note: The file is compressed, and uses the decompression program installed on your computer. WinZip is used in this example. Windows XP has an unzip capability as part of the operating system.

6. Open the file.
7. Double click on the Setup icon.
 - It is not necessary to decompress the DualTapAccuPiXEL.CAB file

FIGURE 1. Setup installs Dual Tap AccuPIXel v 2.5.0

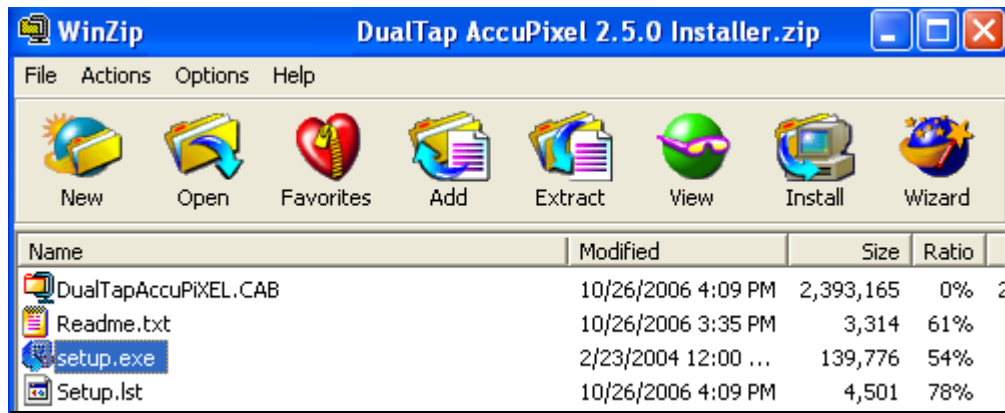

8. Follow the Setup instructions.

FIGURE 2. AccuPIXel Setup screen

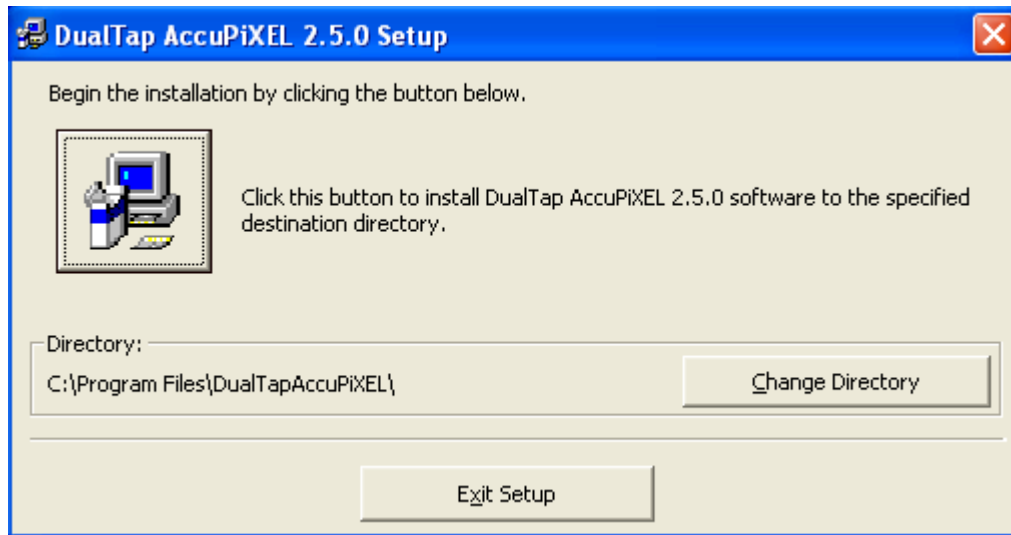

Note: Change the installation directory if desired.

FIGURE 3. Follow the installation directions

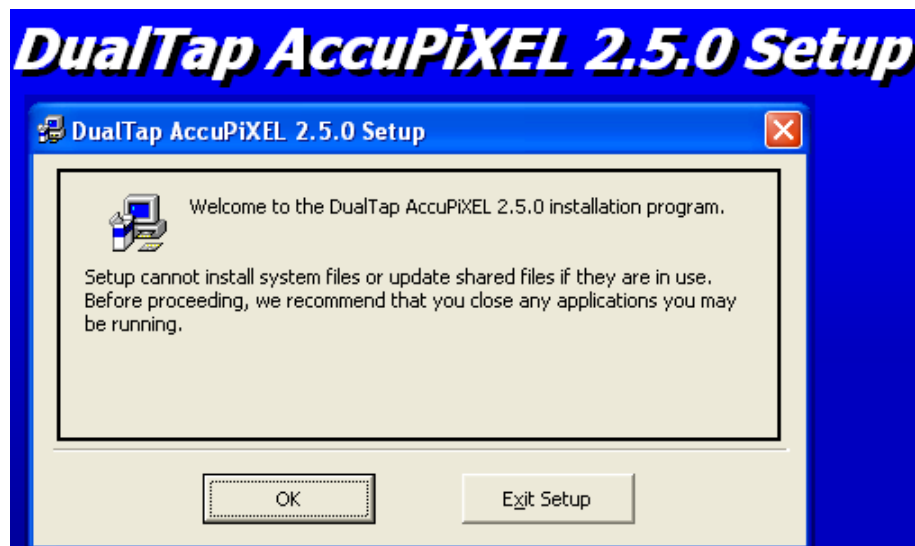

1.1.3 Installing the Camera Link API DLL (clserXXX.dll)

To install the Camera Link control software with frame grabber software, please consult the frame grabber company or JAI PULNiX.

1.1.4 Running Dual Tap AccuPIXEL

Click *Start=>All Programs=>DualTapAccuPIXEL=>DualTapAccuPIXEL* to run the software

The Dual Tap software fails to start if the frame grabber .dll is missing. This may happen because the link to the .dll is lost, if the previous version of dual tap software was uninstalled, or if a frame grabber

has not been installed. If JAI Cam-2-Net software is being used and was installed with the default pathway, the screen grabber is located at C:\CameraLink. If necessary use the Window Search feature to find the needed dll file. Probably the most effective search is to look for the .dll extension. Copy the extension and paste it in the required location.

FIGURE 4. The screen grabber has an essential .dll file.

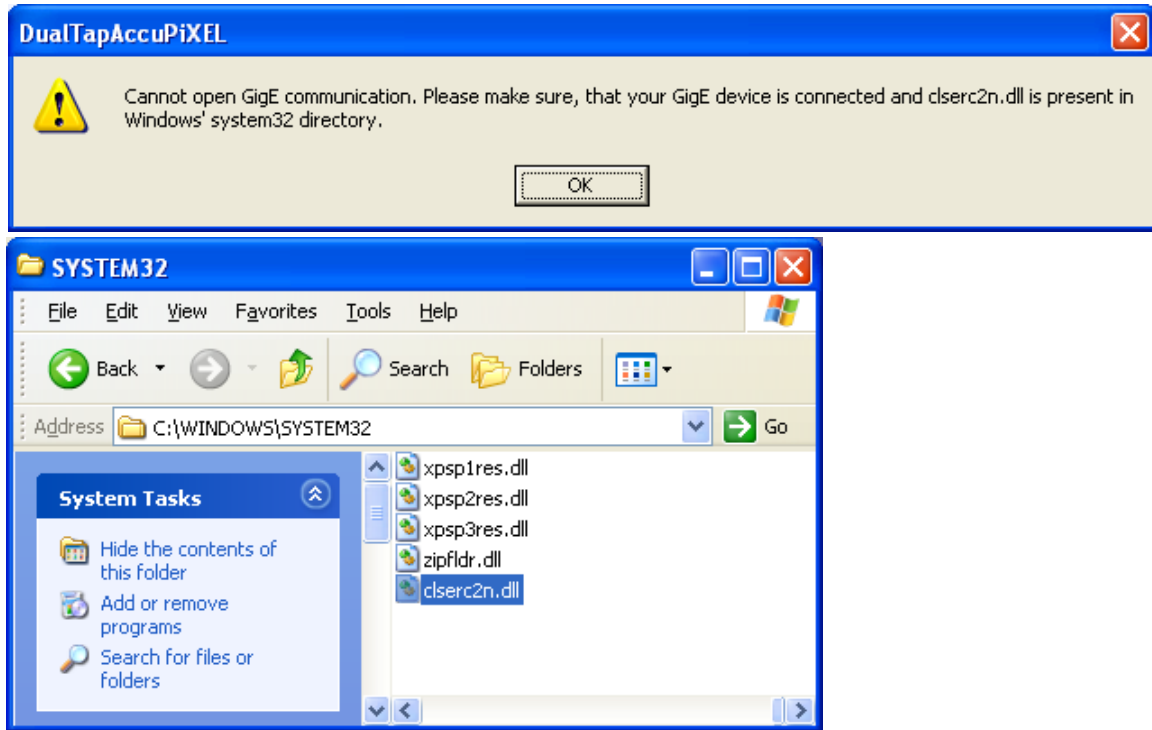

1.1.5 Uninstalling the Software

To uninstall the Dual-Tap AccuPiXEL series camera-control software from the control panel, follow the steps below.

1. Open "Add or Remove Programs" in the control panel.
2. Select *Dual Tap AccuPiXEL* from the lists of the installed software.
3. Click the *Change or Remove* button.

FIGURE 5. “Add or Remove Programs” utility uninstalls older software.

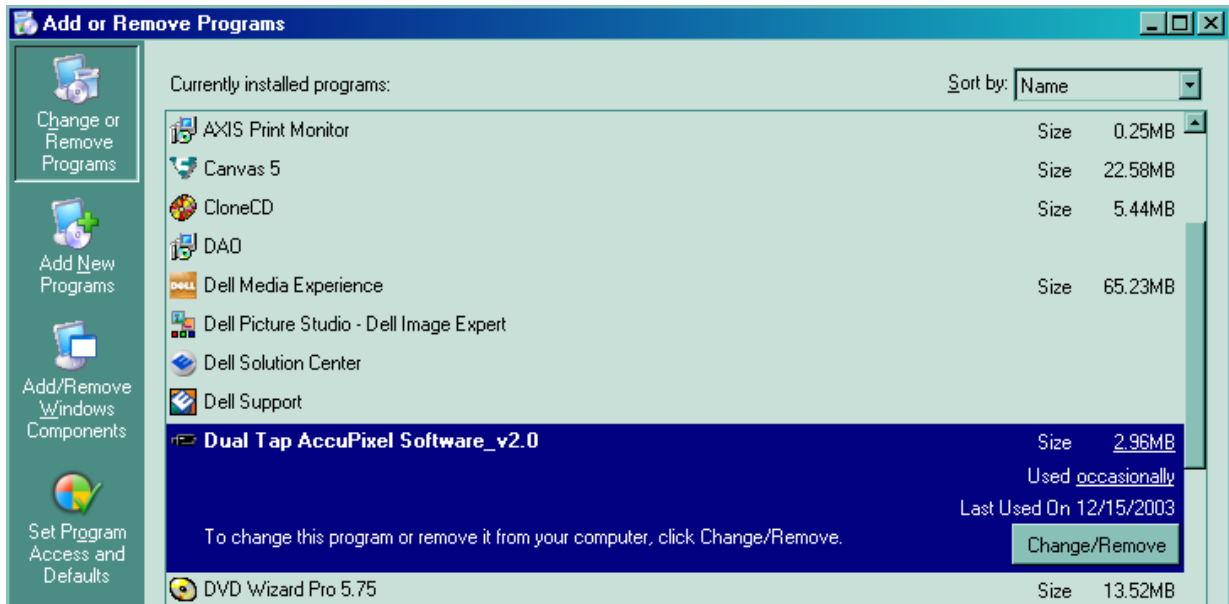

2 TM/TMC-4200CL Camera

FIGURE 6. Back of the TM/TMC 4200CL

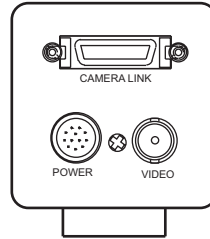

The camera must have all cables properly connected and any required adapters installed and configured to allow the software to perform the operations on the interface.

3 Graphical User Interface

3.1 GUI Features

The following is a list of camera functions that PC serial commands control. The Dual-Tap AccuPiXEL series Camera Link cameras use differential serial communication through the Camera Link connector on the rear panel of the camera. The interface shown here is for the TM/TMC 4200 CL cameras.

FIGURE 7. Main DualTap AccuPiXEL Window

- Exposure Control
 - Continuous
 - Trigger
 - Shutter Speed
 - Expo(Lines)
- Scan
 - Area
 - Mode
- Gain Control
 - Master Gain
 - R Fine Gain
 - R Auto Gain check box
- Offset Voltage
 - Master Offset
 - R Fine Offset
 - R Auto Offset
- Taps
 - Dual Tap
 - Single Tap
- Video Depth
 - 8-bit
 - 10-bit
 - 12-bit
- Image Pre-processing
 - Enable Blemish Compensation
 - Blemish Calibration
- Control Signals
 - CL
 - 12Pin
- Trigger
 - Active High
 - Active Low
- LUT
 - Positive
 - Negative
 - Table: Linear
 - X1: 0, Y1: 0
 - X2: 255, Y2: 255
 - Send Knees
 - Left Knee: (0,0), Right Knee: (255,255)
 - 0, 63, 127, 191, 255 (x4)
 - Knee
- Production
- Report

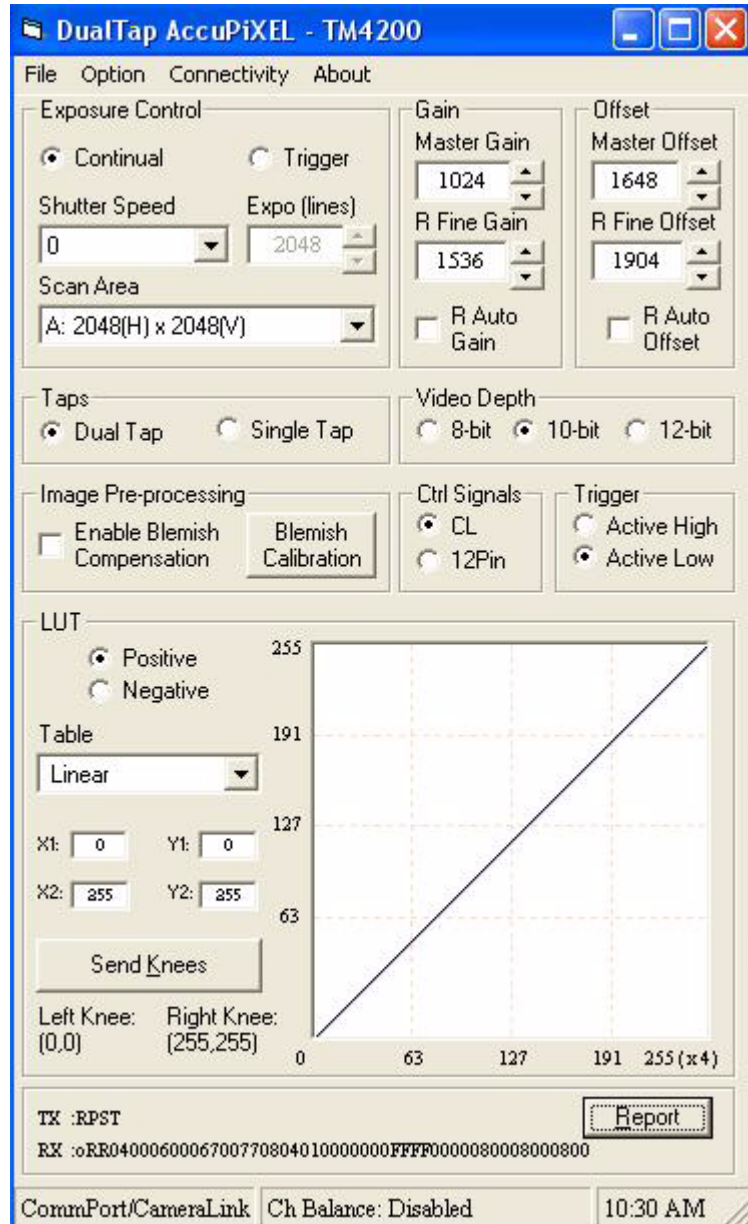

3.2 Using the CamLink Mode

- When CamLink mode is selected, the camera searches for the DLL to the frame grabber. Click the GO button. Choose the dll for the desired frame grabber.

FIGURE 8. Setting up CamLink

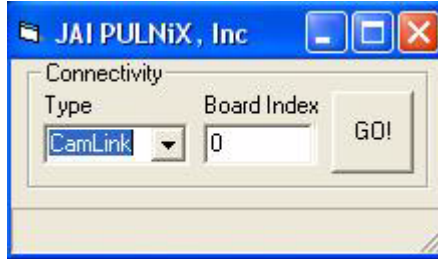
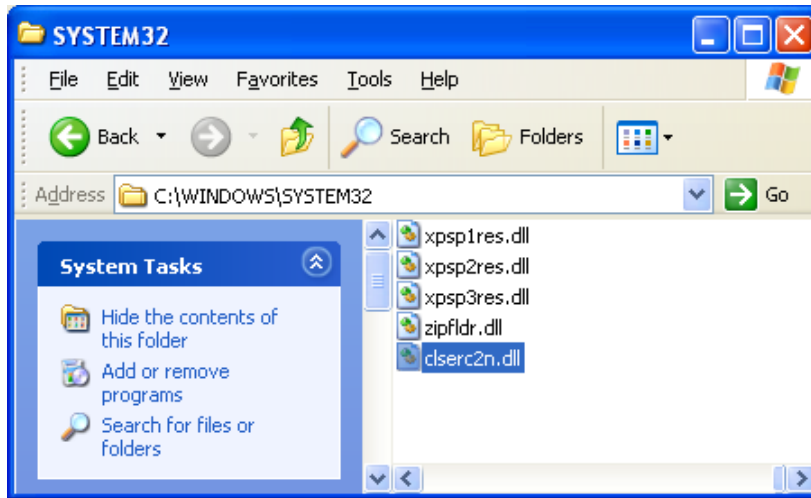
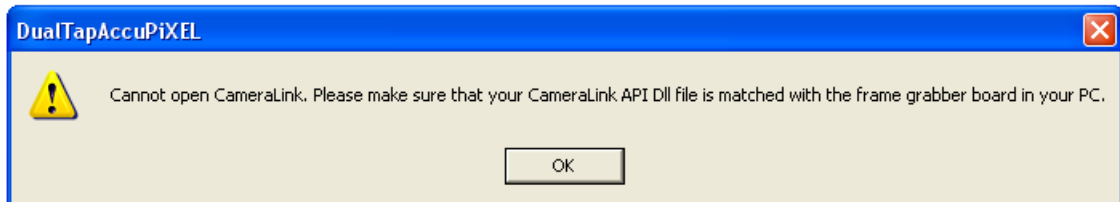

FIGURE 9. Choose the desired frame driver .dll



- If the frame grabber that corresponds to the dll is not present, an error message displays.

FIGURE 10. An error message appears if the .dll application is missing.



- Click *Start=>All Programs=>DualTapAccuPiXEL=>DualTapAccuPiXEL* to open the Dual Tap software.

3.2.1 GigE Mode

GigE mode is not supported for the CL camera.

3.3 Operating The Control Software

3.3.1 Check Current Camera Setting

Click the “Report” button to get the current camera setting from the camera. The Report button also queries for the camera’s current settings and refreshes the screen. To read the detailed report, refer to the Table 8 on page 51 for existing codes.

FIGURE 11. The report frame is near the bottom of the window.

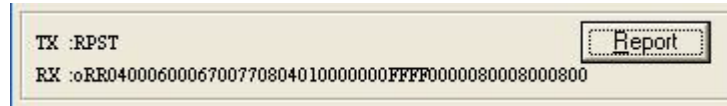

3.3.2 Exposure Control

The TM-4200CL exposure control allows you to select Continuous or Trigger modes using the appropriate option button. Notice that Continuous and Trigger mode offer slightly different menus.

3.3.2 (a) Shutter Speed

The Shutter Time drop-down list box allows you to select the specific shutter speed for manual shutter and Async shutter. Manual shutter speed 0 is no shutter mode; Async shutter speed 0 is Async No Shutter mode; Async shutter speed 1~8 is Async preset shutter mode; Async shutter speed 9 is Async no delay shutter mode (pulse width control). For detailed information, please see “Electronic Shutter” on page 38.

FIGURE 12. Continuous mode operates the shutter from the camera settings.

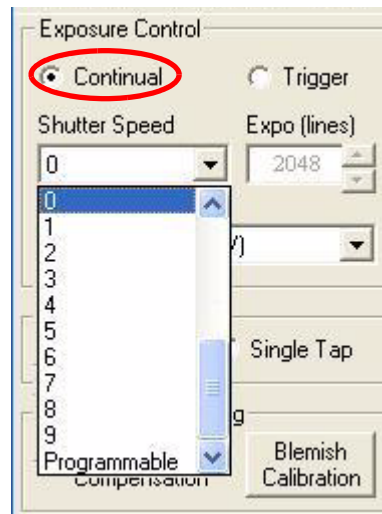

FIGURE 13. Trigger mode uses a manual or sensor command to operate the shutter.

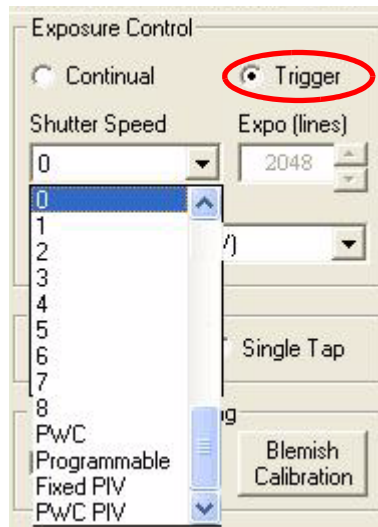
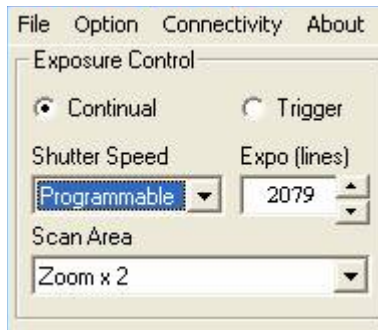

FIGURE 14. To use Programmable shutter speed, select Programmable:



3.3.2 (b) Expo (lines)

The Expo (lines) selection of the Exposure Control frame determines how long the shutter remains open, since a certain amount of time is allotted to expose each line. A minimum of one line of pixels must be exposed. The maximum number of lines is 2079 in Trigger mode. Continual mode is limited to the size of the frame. Enter the number of lines desired either by clicking on the arrows in the interface, or by inputting a number directly into the box beside the “Expo (lines)” box.

3.3.2 (c) Scan Area

Changing the scan area affects the image resolution. If desired, the size of the scan area can be selected from the drop-down list box. When the Scan Area setting is used to designate the number of lines, the rest of the Exposure Control frame is disabled.

FIGURE 15. The Scan Area drop down box.

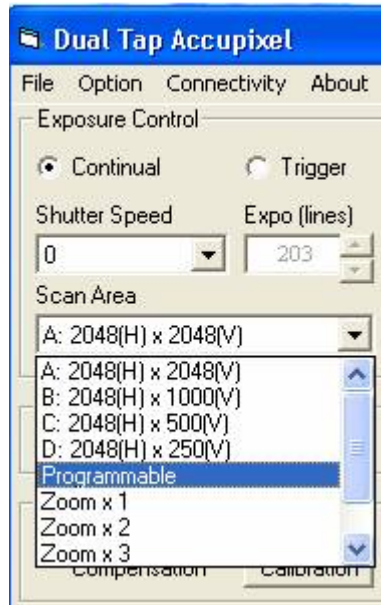

Scan area can vary from a, b, c, or d, to Programmable, various Zoom levels, and more.

FIGURE 16. Enter the starting line number for a programmable scan.

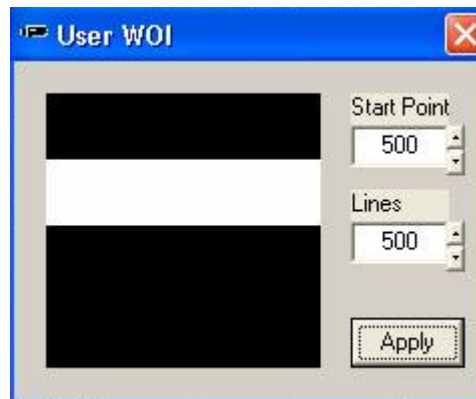

FIGURE 17. Click the Apply button after programming the scan.



3.3.3 Gain Control

3.3.3 (a) Gain

Gain controls the brightness of an image. If the gain number is increased, (for example, 1000 to 2000) the image becomes brighter. If the gain number is decreased, the image becomes dimmer. The Gain Control box allows you to change the Gain value.

When R Auto Gain is checked the camera automatically sets the gain. While the camera is setting the gain the user interface is disabled. Once the gain is set the checkbox clears. Be careful not to send other configuration commands during this process because the camera may not receive the commands.

FIGURE 18. Gain is being set if the R Auto Gain box appears checked.

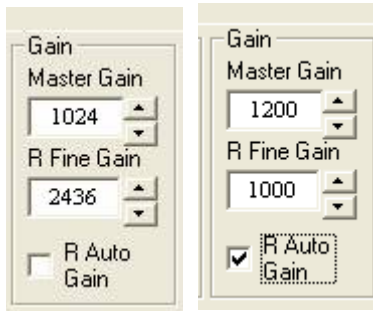

3.3.4 Offset Voltage

Offset is changed by raising or lowering the number in the “Master Offset” or “R Fine Offset” box either by clicking on the arrows or typing a new value in the box.

Checking the “R Auto Offset” checkbox causes the camera to automatically adjust the offset. The camera continues to adjust the offset unless the user unchecks the auto offset; in that case the offset is left off.

When the offset is changed the software does not confirm new setting with an acknowledgement. It is necessary to click on the “Report” button to refresh the screen if you want to confirm the new setting.

FIGURE 19. R Auto Offset box is checked only while the camera sets the command.



Tap Selection:

The TM-4200CL is capable of Dual-Tap or Single-Tap operation. Click the option button for the operation you prefer. Single-Tap operation does not allow the higher data rate permitted by the Dual-Tap output.

FIGURE 20. Click the corresponding option button to set the tap.



3.3.5 Video Depth

Use the option buttons to select 8-bit, 10-bit, or 12-bit output.

FIGURE 21. Click the option button to select Video Depth.

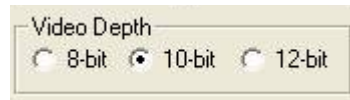

3.3.6 Image Pre-Processing

To activate this control click the “Blemish Calibration” button and then check the “Enable Blemish Compensation” check box. The blemish compensation activates. The lens must be covered with the lens cap during calibration.

Note: Blemish Calibration is necessary only after a camera has been powered off and restarted. Once enabled, blemish compensation remains active unless the user unchecks the “Enable Blemish Compensation” checkbox.

FIGURE 22. Checking “Enable Blemish Compensation” activates Image Pre-Processing.



3.3.7 Ctrl Signals

Use the option buttons to select the control signal that matches your cabling setup, either CL or 12Pin

FIGURE 23. Set “Ctrl Signal” by clicking the option button matching your cabling.

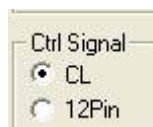

3.3.8 Trigger

Use the option buttons to select either Active High or Active Low.

FIGURE 24. Set “Trigger” by clicking the desired option button.



3.3.9 LUT (Look-Up Table)

The Knee Control box allows you to set your own knee value to each LUT. For more detail regarding knee control, “Programmable Look-Up Table (LUT) and Knee Control” on page 45.

3.3.9 (a) Positive or Negative LUT Selection

The LUT control panel allows you to select the positive or negative LUT. Choosing “Positive” provides a normal image. Choosing the “Negative” option causes the image to appear reversed, as in a film negative.

FIGURE 25. Set “Positive” or “Negative” LUT.

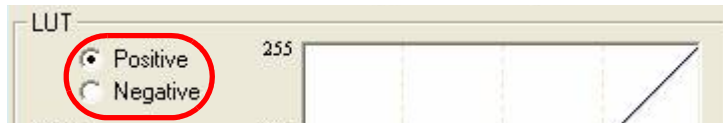

3.3.9 (b) LUT (Look-Up Table) Table Selection

The LUT Table drop-down box offers Linear, Gamma .45 or Knee selections.

FIGURE 26. Table drop down menu:

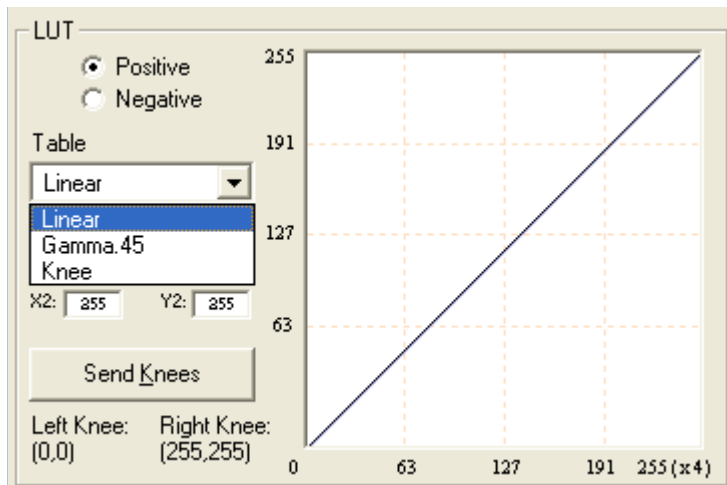

The Table drop down menu offers three options.

The Linear option gathers light in a proportional manner. In this particular selection the LUT is configured to speed the light gathering capability at the beginning of the exposure.

The Gamma.45 option is designed to cause the camera to gather light for a result very similar to what the human eye sees. The heavier curved blue line represents the Gamma.45 LUT adjustment.

FIGURE 27. Gamma.45 imitates human eye sensitivity when creating an image.

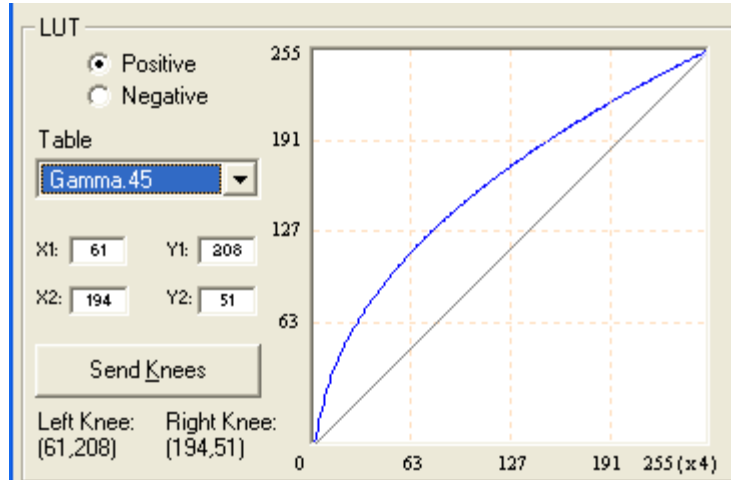

The knee setting allows two adjustments in the light gathering configuration of the LUT to permit the camera to correct images as they are captured. It is possible to set knees on any of the drop down settings by clicking on the existing curve and moving it to the desired configuration. If a drop-down menu setting is selected without adjusting the knees, the camera sets the default.

FIGURE 28. The knee setting activates when “Send Knees” is clicked.

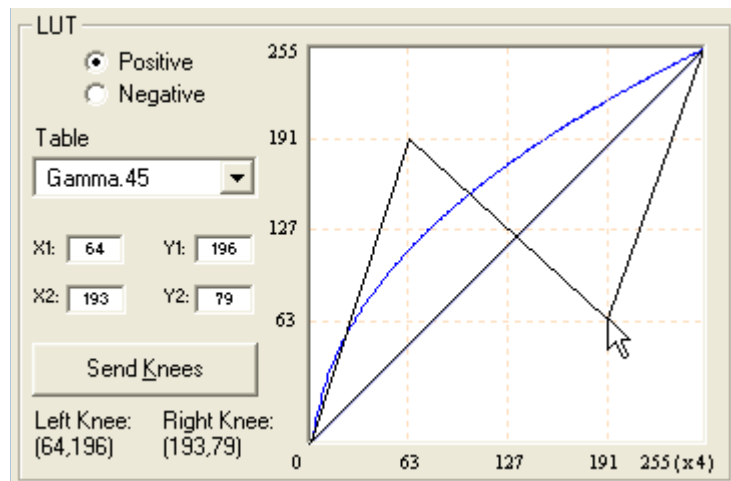

3.3.9 (c) Knee Control

The Knee Control graphical control allows you to change two knee point values visually by clicking and dragging the “knee line.” You may also enter X_1 , Y_1 , X_2 , Y_2 values directly to adjust the knee curve. When you have chosen the value you want and are ready to set this value to the camera, click the “Send Knees” button.

3.3.10 Report Section

The report frame on the bottom of the DualTap AccuPiXEL window provides information about the current settings. The report usually shows the last action, so you can verify at a glance if the camera received a command. After taking an action, such as Send Knees, go to the bottom of the Dual Tap AccuPiXEL TM4200 and click on the Report button. The frame updates to show the most recent action carried out by the camera.

FIGURE 29. The report frame shows the recent camera actions.



To check the entire configuration click on the report button and note the string that appears. To read this string refer to “TM-4200CL Command Response Table” on page 51.

FIGURE 30. A table helps users understand the report screen.

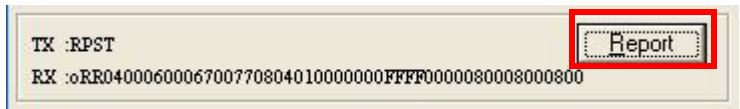

3.3.11 Main Menu: “Option”

3.3.11 (a) Password

Please contact JAI PULNiX for password access. The password allows access to the EEPROM to rewrite factory default settings.



3.3.11 (b) Test Pattern

From the main menu, select “Option” and click “Test pattern” to enable or disable the test pattern

FIGURE 31. Use the “Option” menu to access the test pattern.

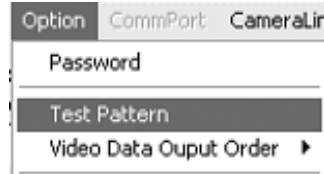

3.3.11 (c) Pixel Output Order

FIGURE 32. Use the “Option” menu to access the test pattern.



From the main menu, select “option” and “Video data output order” and click “<--- <---” or “<--- --->” or “<<-----”

“<--- <---” = First video data are pixel no. 1 and no. 1025.

“<--- --->” = First video data are pixel no. 1 and no. 2848.

“<<-----” = First video data are pixel no. 1 and no. 2.

3.3.12 EEPROM

Dual-tap AccuPiXEL cameras have seven pages available to restore the cameras’ settings. Page 0 is the factory default page and cannot be edited without a password. Page 1 is power up default. This page will allow you to save default setting to load at power up.

3.3.12 (a) Load Page

From the main menu, select “file” and “load page” and click the page number and load camera setting from EEPROM.

3.3.12 (b) Save Page

From the main menu, select “File,” “Save Page,” and click the page number to save the current camera setting to EEPROM.

Note: Page 0 is the factory default page and is protected by password.

3.3.12 (c) Read Page

From the main menu, select “File” “Read Page,” and click the page number to read the EEPROM. When you read the page from EEPROM, the current camera setting will not be changed.

3.3.13 Main Menu “Connectivity”

If the camera has a small receive buffer, it is important to sent the “Receive buffer is small” option from the Connectivity menu. Otherwise the information in the Report section may display in a matter that can not be understood.

FIGURE 33. Use the “Connectivity” menu to set buffer size.



3.3.14 Main Menu “About”

FIGURE 34. The “About” menu provides hardware and software information.

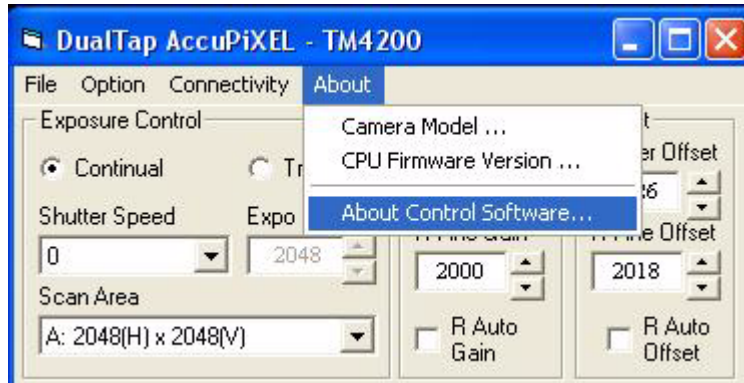

3.3.14 (a) Camera Model

From the main menu, select “About” and click “Camera Model” to check the camera information.

3.3.14 (b) CPU Firmware Version

From the main menu, select “About” and click “CPU Firmware Version” to check the CPU firmware information.

3.3.14 (c) About Control Software

From the main menu, select “About” and click “About Control Software” to check the software information.

3.3.15 Exit

From the main menu, select “File,” and click “Exit” to exit the software.

TM/TMC-4200CL Series Progressive Scan Cameras

Operation Manual



4 Hardware Introduction

4.1 Product Description

The JAI TM-4200CL series consists of dual-tap output, (Camera Link software allows 12-bit, 10-bit, or 8-bit output) high-resolution, high-speed monochrome and color progressive scan CCD cameras.¹ The interline-type CCD permits full vertical and horizontal resolution of very high speed shutter images and applications. The electronic shutter, which has speeds to 1/16,000 sec., can be reset asynchronously by external pulse control. The frame rate is 15 fps. A square imager format with uniform square pixels provides superior image definition in any orientation. On-chip micro lenses provide increased sensitivity.

The TM-4200CL has a full dynamic range control function, which can be set to convert 12-bit input to either 10-bit or 8-bit output through the externally selectable look-up table (LUT)² knee slopes, thereby optimizing the CCD's full dynamic range in the normal output signal range. As a dual-tap output camera, the TM-4200CL has dual-channel auto black level balancing and auto-gain balancing functions. The camera has a single-tap, 12-bit, 10-bit, or 8-bit Camera Link output. All the key functions are controlled by means of the Camera Link serial communication interface.

Synchronized data and clock phases are necessary for multi-camera operations, and a standard feature of all TM-4200CL cameras. The TM-4200CL has a phase lock loop (PLL) to synchronize on the external horizontal drive (Hd) for multi-camera operation that is offered as a standard feature.

-
1. The TM-4200CL series consists of the TM-4200CL (monochrome) and the TMC-4200CL (color). Unless otherwise noted, all information contained in this manual is relevant to both models.
 2. The TM-4200CL has selectable output. The 10-bit and 8-bit output modes have LUT, which the 12-bit output does not have.

Applications for the TM-4200CL include machine vision, medical imaging, intelligent transportation systems, high-definition graphics, on-line inspection, gauging, character reading, archiving, and high-security surveillance.

4.2 Features

- **Miniature size and light weight**

The printed circuit boards in the TM-4200CL have been arranged based on a new design philosophy. This creates modular electronics for the camera, giving it flexibility. In addition, the use of miniature solid-state components results in a compact, lightweight camera that is 51 mm x 51.8 mm x 74 mm in dimensions, and weighs only 152 grams.

- **Imager**

The TM-4200CL uses a dual-tap progressive-scan interline transfer CCD that has the following features:

- Resolution of 2048 x 2048 active pixels for excellent image quality.
- 7.4 x 7.4 μm square pixels for precise dimensional measurement.
- High-speed electronic shutter capability, that eliminates the need for a mechanical shutter through high dynamic resolution of moving objects .
- Progressive-scan CCD eliminates interlace deterioration of image and increases ease of computer interface.
- High sensitivity and low noise with fast scanning rates. The CCD has an excellent S/N ratio that is greater than 54dB.
- The CCD has built-in microlens technology for increased quantum efficiency.

- **Electronic shutter**

The TM-4200CL has a substrate drain-type shutter mechanism which provides superb pictures at various speeds without smearing. For more information, see Section 6.4, "Electronic Shutter," on page 38.

- **Asynchronous reset**

The TM-4200CL captures async reset images and provides single-shot video output with single FDV (frame data valid). This makes it simpler for an ordinary frame grabber to capture the async reset images. The TM-4200CL's asynchronous reset is flexible and accepts external horizontal drive (HD) for phase locking. When the VINIT (5V) pulse is applied to CC1, it resets the camera's scanning and purging of the CCD.

The TM-4200CL has two modes to control the asynchronous reset and shutter speed:

- **External VINIT with pulse width.** The duration between pulse edges controls the shutter speed externally.
- **Internal shutter speed control.** The speed control varies from 1/125 to 1/16,000 sec. The video signal and FDV starts with internal V reset timing originally set to respond to shutter speed, although this can be changed to sensor or other input.

- **Output**
The TM-4200CL has a dual tap/single tap 12-bit, 10-bit or 8-bit Camera Link output. The analog output is 714 mVp-p composite video (75 ohms) on all models.
- **Dual-Channel Auto Black Level Balancing and Gain Balancing**
The TM-4200CL, as a dual-tap output camera, has dual-channel auto black level balancing and auto gain balancing functions.
- **Warranty**
Please contact the JAI factory representative for details about the warranty.

4.3 System Configuration

FIGURE 35. CL (Camera Link) System Configuration

Figure 35 below presents a typical system configuration for the Camera Link version.

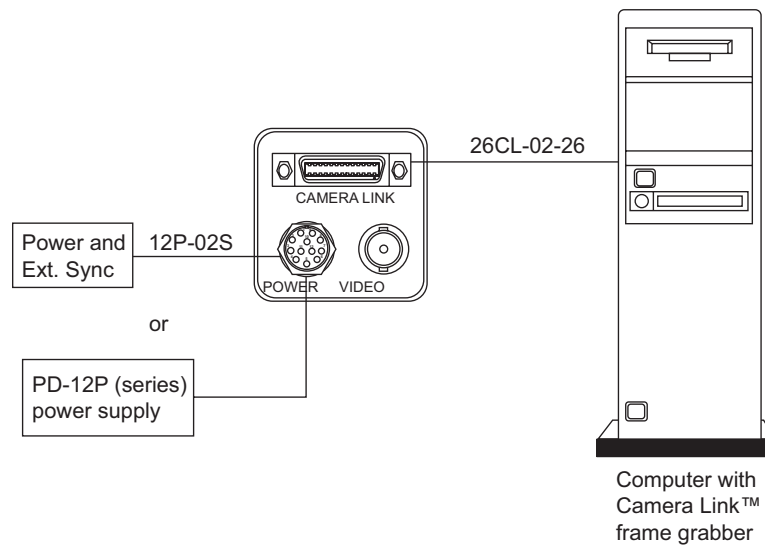

5 Installation

The following instructions are provided to help you to set up your camera quickly and easily. We suggest that you read through these instructions before you unpack and set up your camera system.

5.1 Getting Started

5.1.1 Unpacking Instructions

We recommend that you save the original packing cartons for the cameras and accessories in case you need to return or exchange an item.

We also recommend that you bench-test any equipment being sent to another location for field installation to assure that everything is fully operational as a system.

5.1.2 Components List

Check your order against the Components List shown below to assure that you have received everything as ordered, and that nothing has been overlooked in the packing materials. If any item is missing contact your JAI representative immediately.

- TM-4200CL camera
- Camera-specific data sheet
- Camera-appropriate operation manual (if ordered)
- Dual-tap AccuPiXEL camera-control software

5.1.3 Accessories and Options

Following is a list of additional accessories and options that may be required for your application. Please check with your JAI representative before you install your camera to determine what you might need.

- PD-12U series power supply
- 12P-02S power cable
- 26CL-02-26 Camera Link cable

5.2 Camera Setup

5.2.1 Heat Dissipation

The TM-4200CL is a compact 2K by 2K camera. Since all the electronics have been packed in a compact package, the outer case of the camera can become hot due to heat dissipation. For optimal performance, JAI recommends using a cooling fan to set up a positive air flow around the camera and following the precautions below.

- Mount the camera on a large heat sink (camera bracket) made out of heat-conductive material like aluminum.
- Make sure the flow of heat from the camera case to the bracket is not blocked by a non-conductive material like plastic.
- Make sure the camera has enough open space around it to facilitate the free flow of air.

Please contact JAI at (800) 445-5444 or send an E-mail to imaging@pulnix.com if you have any questions.

5.2.2 Connector Pin Configurations

5.2.2 (a) 12-Pin Connector

The TM-4200CL has a 12-pin Hirose connector for power input and signal integration. Pin #1 is Ground and pin #2 is +12V DC. The pin-out table is shown below. Serial communication camera control is accomplished by means of the Camera Link connector on the rear panel of the camera.

TABLE 1. 12-Pin Connector

Pin	Description	Pin	Description
1	GND	7	VD in
2	+12V DC	8	Strobe
3	GND (analog)	9	HD in
4	Video out	10	NC
5	GND (digital)	11	Reserved
6	VINIT in	12	NC

FIGURE 36. Hirose Connector

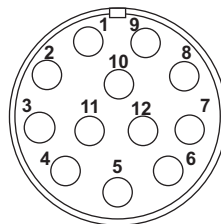

5.2.2 (b) Digital I/O Connector

The TM-4200 has a 26-pin connector on the rear panel to output Camera Link data. The connector pin-out is shown in Table 2 on page 24

FIGURE 37. 26-pin Camera Link Connector.

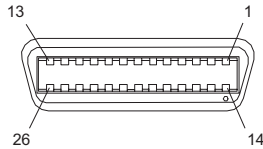

TABLE 2. Connector and Pin-out Configurations

Camera Link Connector					
Pin #	Description	I/O	Pin #	Description	I/O
1	GND		14	GND	
2	Tx OUT 0-	Out	15	Tx OUT 0+	Out
3	Tx OUT 1-	Out	16	Tx OUT 1+	Out
4	Tx OUT 2-	Out	17	Tx OUT 2+	Out
5	Tx CLK OUT -	Out	18	Tx CLK OUT+	Out
6	Tx OUT 3-	Out	19	Tx OUT 3+	Out
7	SerTC+	In	20	SerTC-	In
8	SerTFG-	Out	21	SerTFG+	Out
9	VINIT	In	22	VINIT+	In
10	Reserved	In	23	Reserved	In
11	EX-HD-	In	24	EX-HD+	In
12	EX-VD+	In	25	EX-VD-	In
13	GND		26	GND	

Note: SerTC: Serial To Camera
SerTFG: Serial to Frame Grabber

5.2.2 (c) Analog Output Connector

The TM-4200CL has a BNC connector on the rear panel to output the analog video signal. Analog output is available to drive auto-iris lenses and troubleshooting.

Note: This analog signal is not an RS-170 (television format) signal that can be connected to a standard CCTV monitor.

FIGURE 38. BNC Connector.

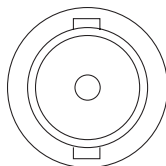

5.2.3 Camera Link Cable

The 26CL-02-26 cable assembly has been standardized as the Camera Link cable. This cable has a 26-pin connector on both ends. This is a straight-through cable and the pin-out configuration is shown in Table 2 on page 24. Contact JAI for cable lengths other than 2 meters.

FIGURE 39. 3M Camera Link Cable

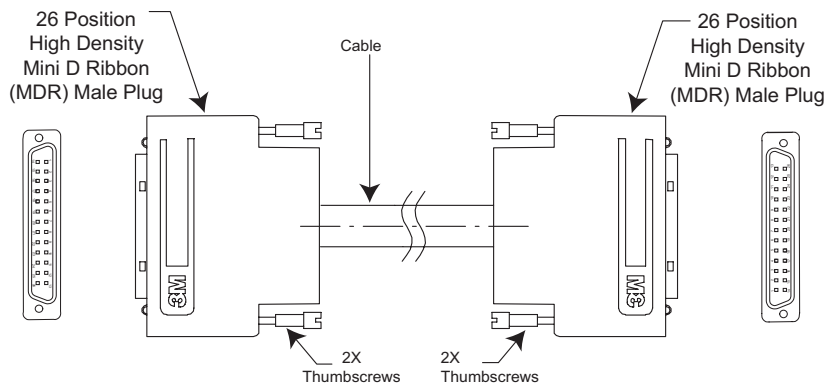

Note: For CL versions, serial communication for camera control is accomplished by means of the Camera Link connector on the rear panel of the camera.

5.2.4 Power Supplies and Power Cable Setup

5.2.4 (a) Power Supplies

The TM-4200CL camera requires 12V DC power that is obtained through the 12-pin connector located on the rear panel of the camera. JAI recommends the following power supplies:

PD-12UU	100-240V AC/12V DC	1.2A universal voltage power supply, US Plug
PD-12UUP	PD-12UU with 12-pin connector	US plug
PD-12UE	PD-12UU	European plug
PD-12UEP	PD-12UU with 12-pin connector	European plug

For users providing power through the 12-pin connector, the PD-12P, PD-12UEP and PD-12UUP power supplies are available with the 12-pin mating connector already attached to the leads from the power supply. The PD-12UU and PD-12UE power supplies can be connected to the JAI power cable by means of a terminal strip or directly.

When wiring the PD-12UU and PD-12UE power supplies directly, please note the following:

- The lead ends must be twisted together and tin-soldered for strength and electrical continuity.
- Use shrink tubing or a similar insulator to prevent exposed leads from touching and shorting.

- The +12V lead is marked with a red stripe or white lettering; be sure not to reverse the leads.
- All connections must be properly insulated to prevent shorting.

5.2.4 (b) JAI Power Cables

When using JAI power cables such as the 12P-02S, please refer to the 12-pin connector pin-out diagram below. The cable pin-out diagram is shown in Figure 40 below. The color-coded leads use Gray for Ground and Yellow for +12V.

FIGURE 40. 12P-02S Interface Cable (optional)

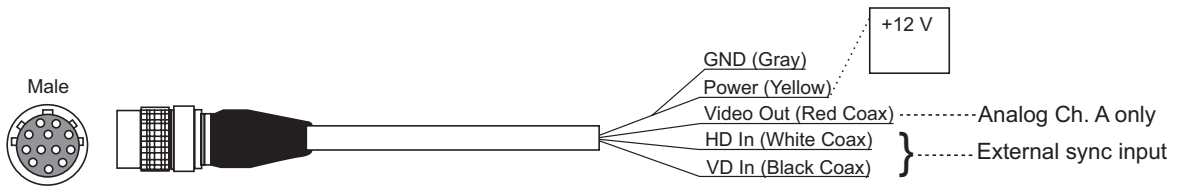

FIGURE 41. 12P-02S Interface Cable Pin Out

12P-02S Interface Cable					
Pin#	Lead Color	Function	Pin#	Lead Color	Function
1	Gray	GND	7	Black coax	VD Input
2	Yellow	+12V DC	8	White coax shield	Strobe out
3	Red coax shield	GND (analog)	9	White coax	HD Input
4	Red coax	Video Out	10	Brown	RXD
5	Orange coax shield	GND (digital)	11	Blue	Reserved
6	Orange coax	VINIT IN	12	Black coax shield	TXD

Note: Make sure that the unused leads are not touching and that there is no possibility that exposed wires could cause the leads to short.

5.2.4 (c) Building Your Own Power Cable

Refer to the 12-pin connector pin-out in Figure 40 on page 26. Connect the Ground lead to pin #1, and the +12V DC lead to pin #2 of the 12-pin connector. Power must be DC-regulated, and of sufficient current to properly power the camera.

5.2.4 (d) Attaching the Power Cable to the Connector

The 12-pin connector is keyed and will only fit in one orientation. Follow these directions to properly attach the power cable to the camera connector:

1. Rotate the connector while applying slight pressure until the keyways line up.
2. Press the connector into place until firmly seated.
3. Plug the power cord into the 100V AC socket. This will power up the camera.

5.2.5 Attaching the Analog Video Output

When connecting the TM-4200CL to an analog frame grabber or a monitor, use the BNC connector on the back panel of the camera. The input of the monitor should be balanced for 75 ohms termination. Standard RG-59 type coaxial cable should carry a full video signal for up to 500 feet. The TM-4200CL has a two-row binning mode that can be used to display real-time images on the PVM-942 or PVM-1242 monitors. These monitors are specially modified to accept a 30Hz progressive scan image.

The multi-conductor cable 12P-02S can transmit analog video, power, sync. signals, and serial communication. The mini coaxial leads in JAI multi-conductor cables are designed for short runs of no longer than 50 feet.

Note: Make sure that no extraneous wires are visible which could cause a short.

5.2.6 Attaching the Camera Lens

The TM-4200CL camera accepts 1.2-inch or larger format size C-mount lenses. To attach the C-mount lens¹ to the camera, carefully engage the threads and rotate the lens clockwise until it firmly seats on the mounting ring. Do not force the lens if it does not seat properly. Please note that some lenses with extremely long flangebacks may exceed the mounting depth of the camera.

1. C-mount to F-mount and C-mount to K-mount adapters are available for larger format lenses (35mm). Check with local photography dealers for these lens adapters.

6 Functions and Operations

6.1 Camera Rear Pane

FIGURE 42. Camera Connectors

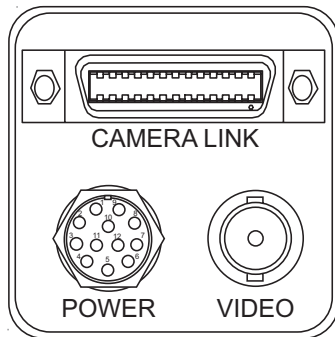

6.1.1 Digital I/O Connector (Camera Link)

Refer to Section 5.2.3 on page 25 for information on digital output connectors.

6.1.2 Analog Output Connector

The camera has a BNC connector on the back panel to output the analog video signal.

6.1.3 Power and External Sync Connector

Refer to Section 5.2.2 (b) on page 24 for information on the power and external sync. connectors.

6.2 Sensor Layer and Timing

FIGURE 43. Digital Video Output

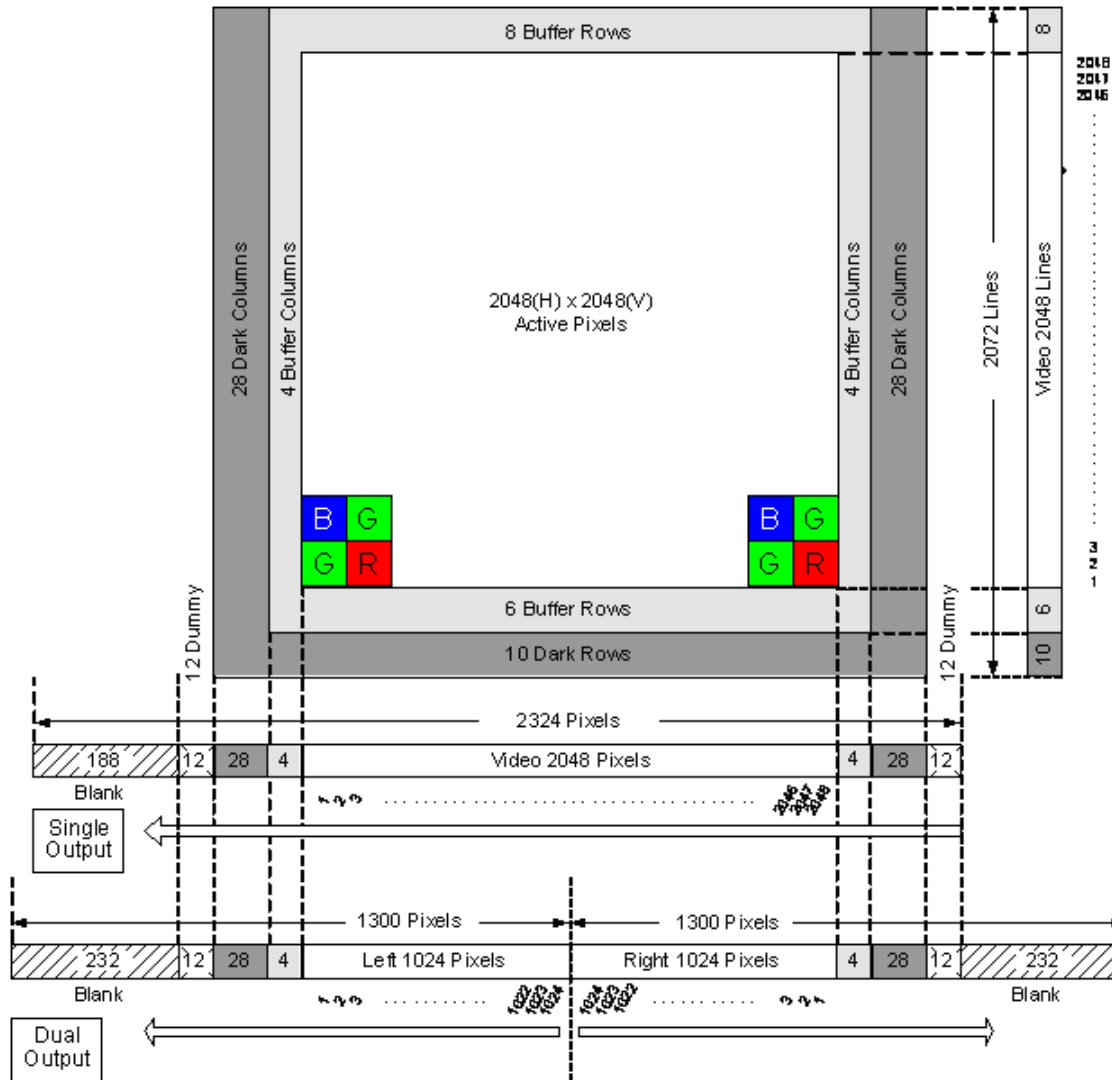

The CCD sensor layout is shown as it is used in the timing video readout in respect to pixels and lines. For the TMC-4200CL the effective full frame Bayer sequence starts with GRG. For partial scan the sequence starts with GRG for the odd lines, and BGB for the even lines.

FIGURE 44. Camera Timing Chart

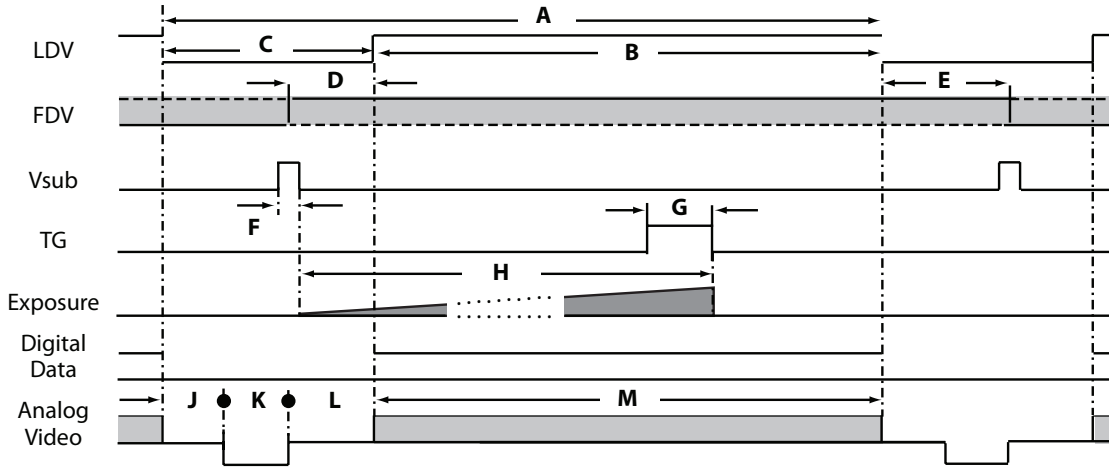

FIGURE 45. Digital Data Output Order for Configuration

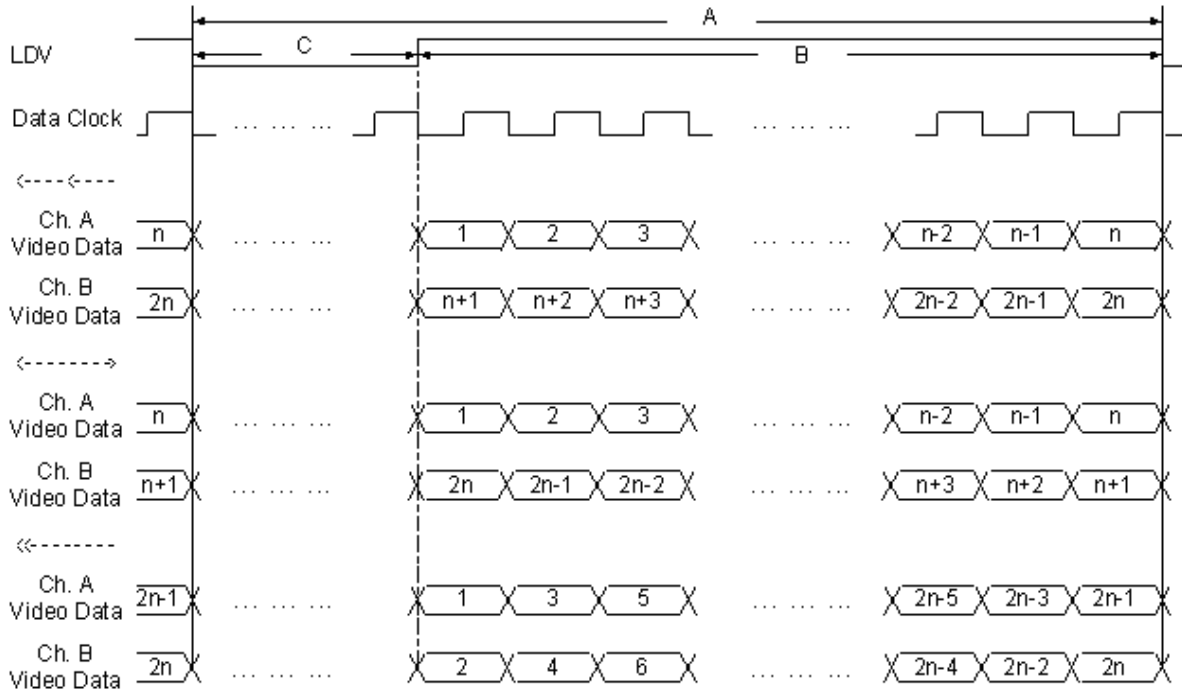
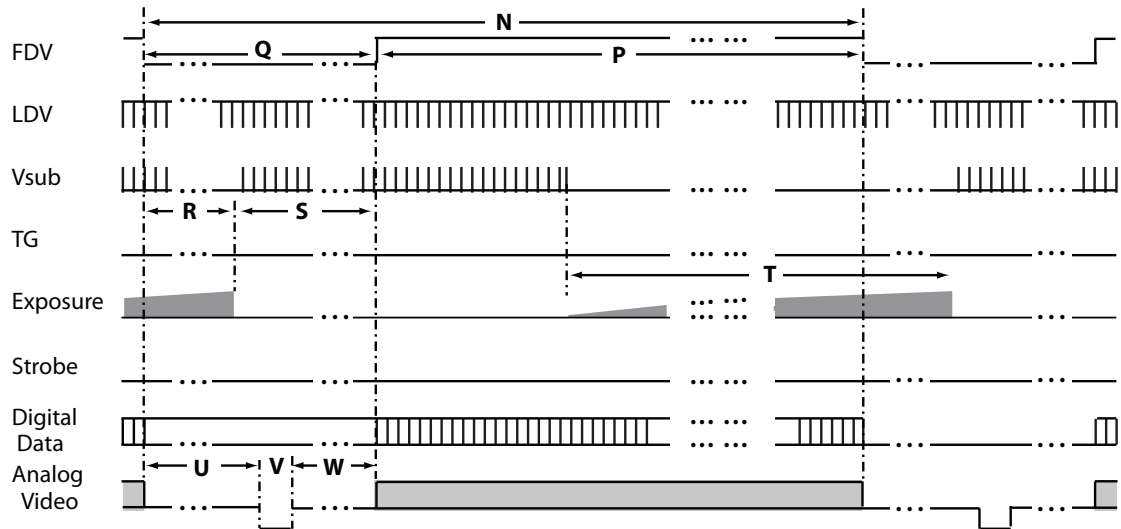

FIGURE 46. Field Video Timing--Continuous Mode



6.3 Scan Area

6.3.1 Preset Scan Area

TM/TMC-4200 has four fixed Scan Area Modes: full scan, centered 1000 lines, centered 500 lines, and centered 250 lines. In full scan mode, all active lines of the CCD sensor, 2048 lines, are transferred out line by line. In centered mode 1000 lines are transferred out, in 500 line and 250 line mode, only the centered lines are transferred out line by line. The rest of the lines are dumped out using the fast dump function of the CCD. This transfer method causes the frame rate of each mode to vary.

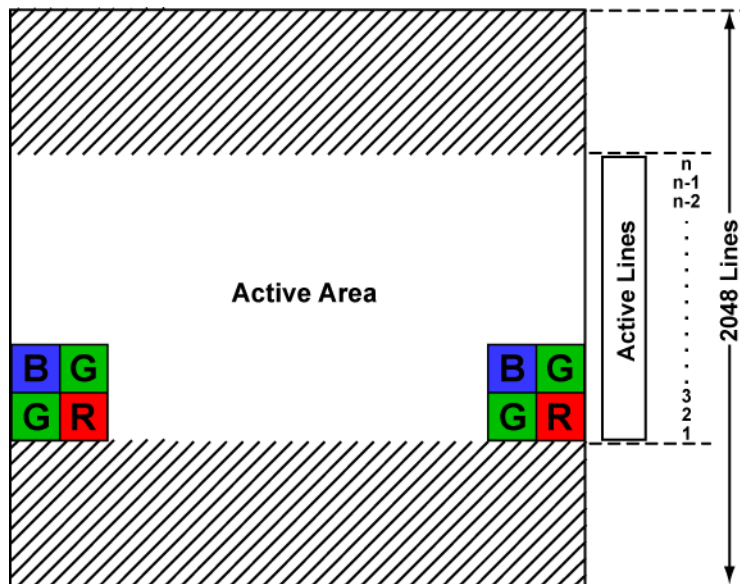

6.3.2 Programmable Scan Area

In Programmable Scan Area Mode, users can specify both the start point of the active scan area and the total active lines through the serial communication commands. The area selected by users is transferred out line by line. The rest of the lines are dumped out using the fast dump function of the CCD. The frame rate in this mode varies according to the selected active area. When the active area starts from x row, and the active lines are y lines, the frame rate can be calculated using the following formulas.

$$Frame\ Rate = \begin{cases} \frac{1}{((n_f + 16) + n_r) * 32.5\ \mu s} & \text{Dual Tap} \\ \frac{1}{((n_f + 16) + n_r) * 58.1\ \mu s} & \text{Single Tap} \end{cases}$$

Where,

$$n_f = \begin{cases} \text{int}\left(\frac{x+16}{N}\right) & \text{remainder of } \frac{x+16}{N} = 0 \\ \text{int}\left(\frac{x+16}{N}\right)+1 & \text{remainder of } \frac{x+16}{N} \neq 0 \end{cases}$$

$$n_r = \begin{cases} \text{int}\left(\frac{2056-x-y}{N}\right) & \text{remainder of } \frac{2056-x-y}{N} = 0 \\ \text{int}\left(\frac{2056-x-y}{N}\right)+1 & \text{remainder of } \frac{2056-x-y}{N} \neq 0 \end{cases}$$

$$N = \begin{cases} 8 & \text{Dual Tap} \\ 15 & \text{Single Tap} \end{cases}$$

For a color CCD, the upper-left Bayer pattern changes, depending on the start point location. If the start point is the odd row, the upper-left Bayer pattern is G. In RG if the start point is the even row, the upper-left bayer pattern is B in BG.

FIGURE 47. Bayer 1

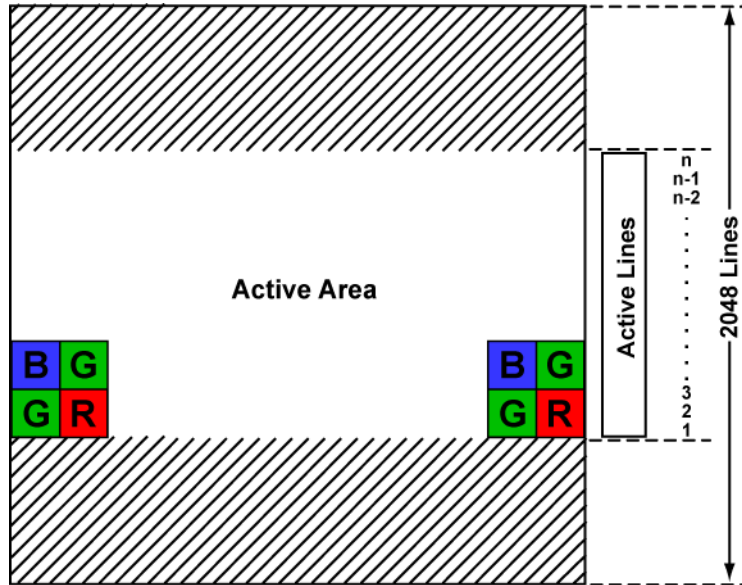
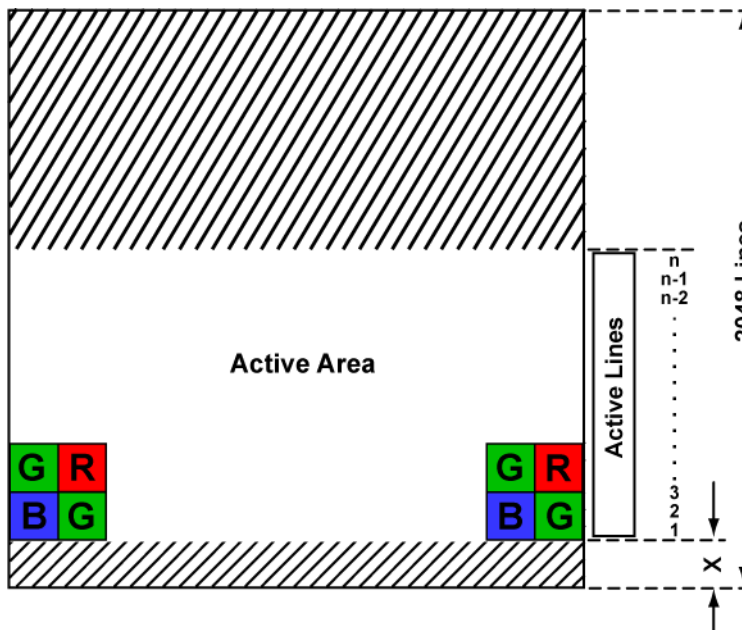

FIGURE 48. Bayer 2



6.3.3 Full Scan Area 2x2 Binning

TM-4200 CL offers 2x2 binning of the full scan area. In full scan 2x2 binning mode, pixel (i, j) includes all the information of pixel (2i-1, 2j-1), (2i-1, 2j), (2i, 2j-1) and (2i, 2j) in normal full scan mode (where i, j=1 2, ..., 1024). In this mode vertical binning makes frame transfer faster than normal scan mode, however, due to the mixture of pixel information, the camera resolution is low in this mode, and the Bayer pattern CCD camera loses color information.

FIGURE 49. 2x2 Binning

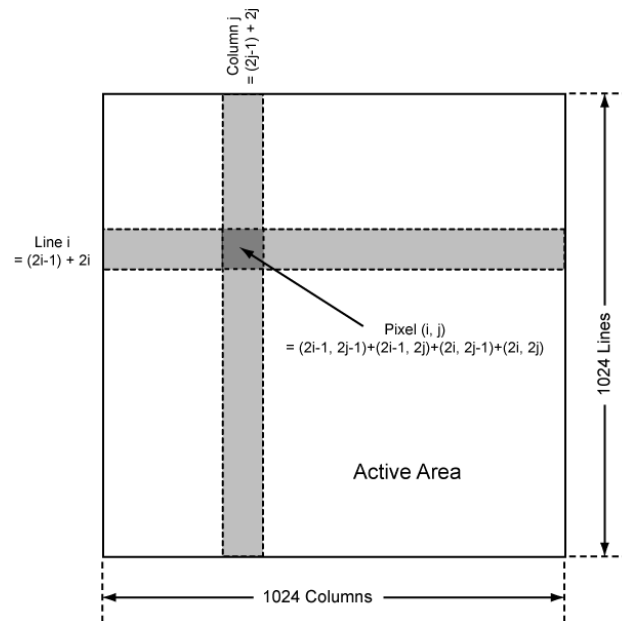

6.3.4 Sub-sampling Digital Zoom

TM-4200CL has four sub-sampling digital zoom modes: 1x, 2x, 3x, and 4x. Effective pixels in these modes are 512(H) x 1024(V).

- In 1x mode, the output video uses all the pixels in the center 512(H) x 512(V) of the CCD sensor.
- In 2x mode the output video is every other pixel in the horizontal row, and every other line in the vertical rows at the center 1024(H) x 1024(V) of the CCD sensor.
- In the 3x mode the output video is every other two pixels in the horizontal row and every other two lines in the vertical row of the center 1536(H) x 1536(V) of the CCD sensor.
- In 4x mode output video is every other three pixels in the horizontal row, and every-other three lines in the vertical rows of the full scan area, which is 2048(H) x 2048(V).

FIGURE 50. Sub-sampling Digital Zoom

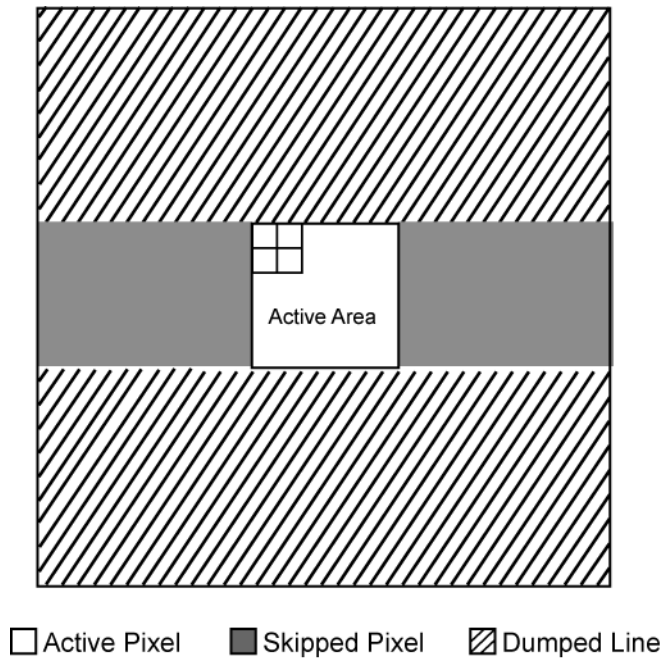

FIGURE 51. Sub-sampling Digital Zoom 2x

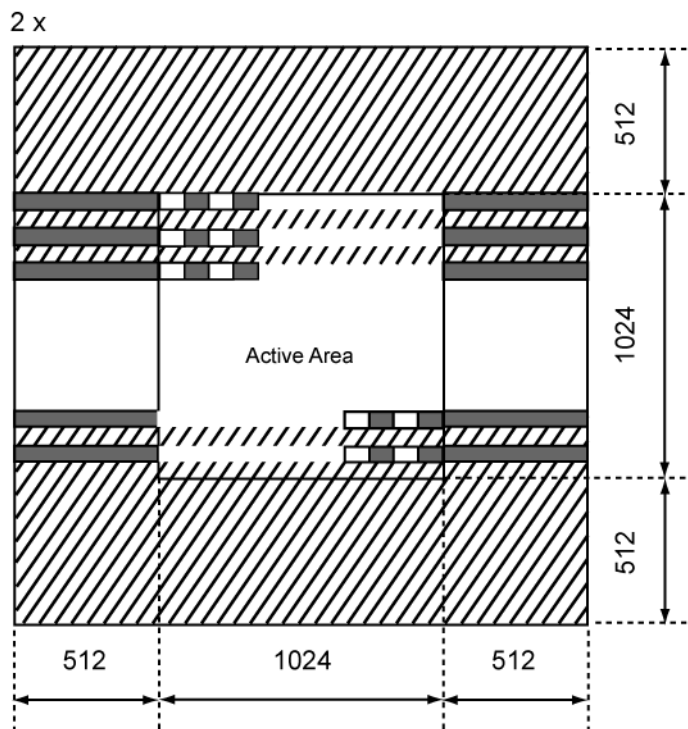

FIGURE 52. Sub-sampling Digital Zoom 3x

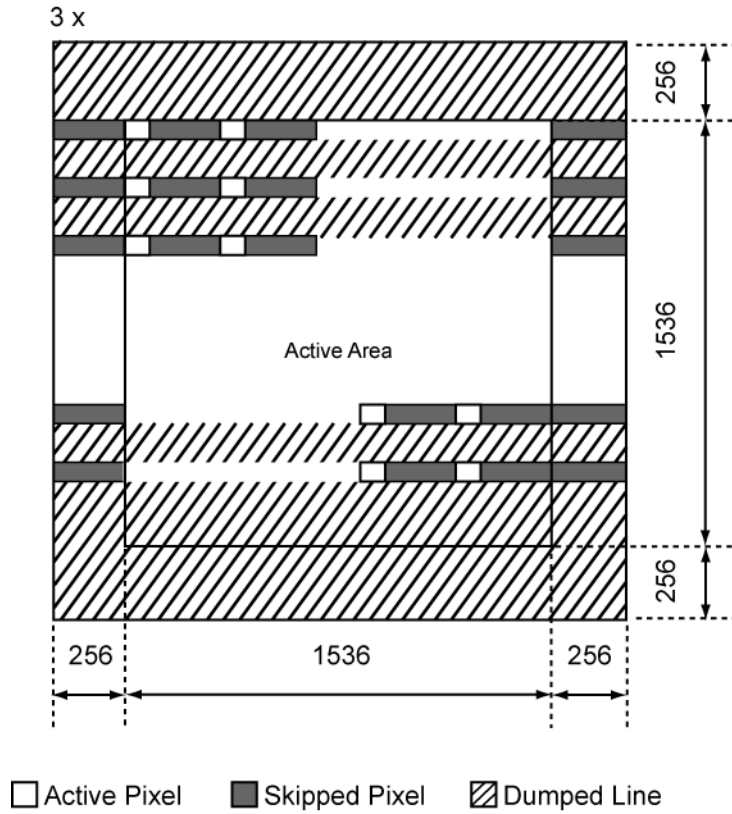

FIGURE 53. Sub-sampling Digital Zoom 4x

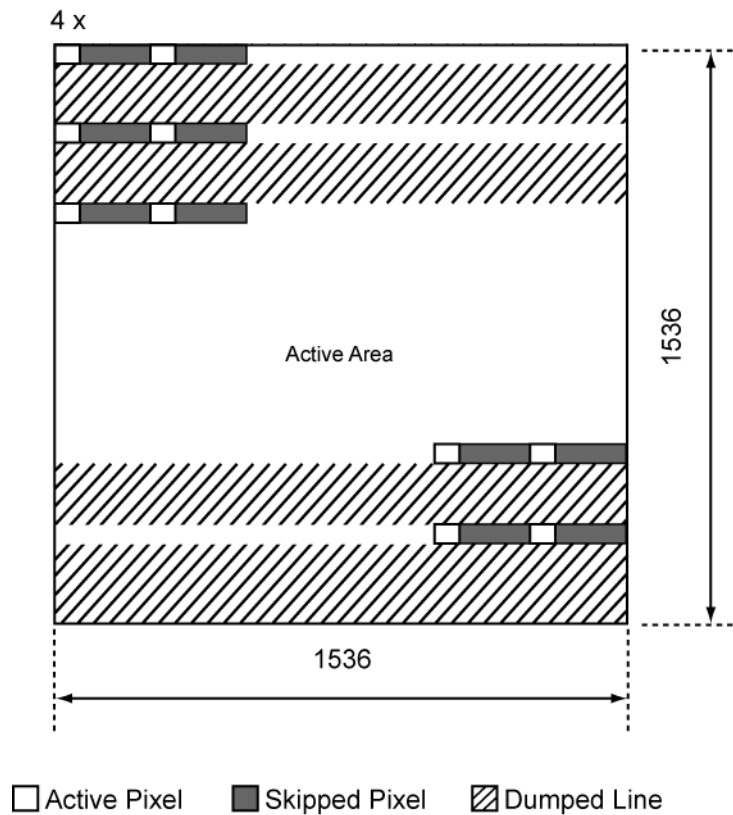

TABLE 3. Scan Area Start Points

	Scan Area	Start Point (Line)	Effective Area (Lines x Pixels)	Frame Rate	
				Dual Tap	Single Tap
A	Full Scan	1	2048 x 2048	14.79	8.04
B	Centered 1000 Lines	525	1000 x 2048	27.97	15/20
C	Centered 500 Lines	775	500 x 2048	49.63	26.97
D	Centered 250 Lines	901	250 x 2048	79.92	43.43
T	Full Scan 2x2 Binning	1	1024 x 1024	26.42	15.09
Z	Sub-sampling Digital Zoom		512 x 512	31.98	20.40
U	Programmable Scan Area	1 - 2048	1-2048 x 2048		

6.4 Electronic Shutter

The TM-4200CL has a substrate drain-type shutter mechanism which provides a superb picture at various speeds.

6.4.1 Preset Shutter

TABLE 4. Electronic Preset Shutter

Shutter Speed	Dual Tap		Single Tap	
	Continuous Mode (sec)	Async Mode (sec)	Continuous Mode (sec)	Async Mode (sec)
0	No shutter	No shutter	No shutter	No shutter
1	1/60	1/16000	1/35	1/9000
2	1/125	1/8000	1/70	1/4500
3	1/250	1/4000	1/140	1/2250
4	1/500	1/2000	1/280	1/1120
5	1/1000	1/1000	1/560	1/560
6	1/2000	1/500	1/1120	1/280
7	1/4000	1/250	1/2250	1/140
8	1/8000	1/125	1/4500	1/70
9	1/16000	PWC	1/9000	PWC

6.4.2 Programmable Exposure-Continuous Mode

The exposure time of TM-4200CL can be specified from one video line to a maximum of one frame using the serial communication commands in the Continuous Mode. There is overhead where the specified exposure time is n video lines, making the real exposure time equal to

$$\text{Exposure Time} = \begin{cases} (n+1) * 32.5 \mu\text{s} + 25.6 \mu\text{s} & \text{Dual Tap} \\ (n+1) * 58.1 \mu\text{s} + 25.6 \mu\text{s} & \text{Single Tap} \end{cases}$$

When $n=0$, the exposure time is the minimum exposure time. It is equal to:

$$\text{Minimum Exposure Time} = \begin{cases} 58.1 \mu\text{s} (1/17000\text{s}) & \text{Dual Tap} \\ 83.7 \mu\text{s} (1/12000\text{s}) & \text{Single Tap} \end{cases}$$

In this mode the maximum exposure time is equal to the setting for one frame. If the user specified exposure time is longer than the time allowed for one frame, it will be ignored by the camera.

6.4.3 Asynchronous No Shutter Mode

In Asynchronous No Shutter Mode, applying the external trigger starts a camera scan reset. The camera finishes the line it is scanning and scans an additional 9 video lines, this charge is sent to the horizontal register.

Because the external trigger is randomly applied, the new image charge may overlap with the previous image. To prevent an existing charge accumulation from interfering with a new image, most users set up

the application in a dark area and depend on a strobe light for illumination. From the time the external trigger activates until the transfer gate turns off, about 9.5 video lines are available for integration; if everything is properly configured, the strobe flashes during this time.

FIGURE 54. External Trigger Timing.

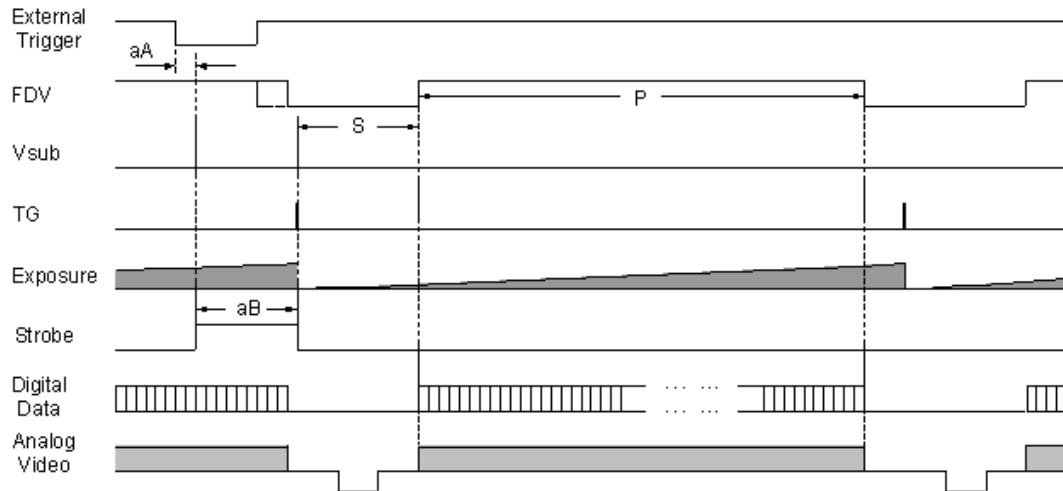

6.4.4 Asynchronous Programmable Exposure Mode

In Asynchronous Programmable Exposure Mode, when an external trigger is applied, the exposure starts after one discharge signal (V_{sub}), which happens after the trigger's active edge is off. Because the discharge signal (V_{sub}) synchronizes with LDV in this mode, there is a maximum one video line of jitter between the trigger active edges to discharge signals (V_{sub}) off. In this mode, the exposure time from 1 video line to 2080 video lines can be controlled through serial communication commands in one video line steps. In this mode, the minimum exposure time is equal to 1 video line plus overhead: the maximum exposure time is equal to 2080 video lines plus overhead. Where the specified exposure time is n video lines, the real exposure time is equal to:

$$Exposure\ Time = \begin{cases} (n+1) * 32.5\ \mu s + 25.6\ \mu s & \text{Dual tap} \\ (n+1) * 58.1\ \mu s + 25.6\ \mu s & \text{Single tap} \end{cases} \quad (n = 0, 1, \dots, 2079)$$

When $n=0$, the exposure time is minimum exposure time. It is equal to:

$$Minimum\ Exposure\ Time = \begin{cases} 58.1\ \mu s \ (1/17000s) & \text{Dual tap} \\ 83.7\ \mu s \ (1/12000s) & \text{Single tap} \end{cases}$$

When $n=2079$, the exposure time is maximum exposure time. It is equal to:

$$Maximum\ Exposure\ Time = \begin{cases} 67625.6\ \mu s \ (1/15s) & \text{Dual tap} \\ 120873.6\ \mu s \ (1/8s) & \text{Single tap} \end{cases}$$

When $n=2079$, the exposure time is maximum exposure time. If the exposure time is less than the time available for one frame, the maximum trigger frequency is equal to 1/1 frame time. If the exposure time is longer than the time available for one frame, the maximum trigger frequency is equal to 1/exposure time.

The minimum active period of the external trigger is 5 μ s.

FIGURE 55. Asynchronous Programmable External Trigger

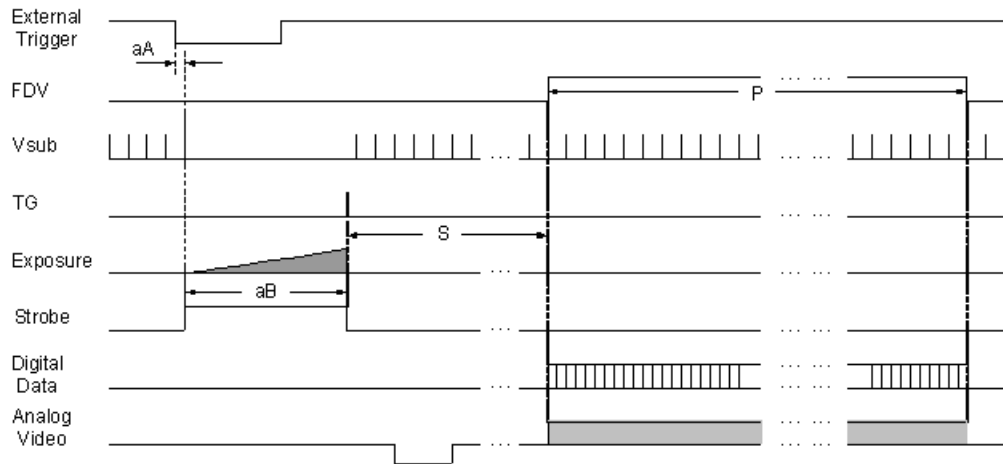

6.4.5 Pulse Width Control Mode

In Pulse Width Control (PWC) Mode, the exposure time is controlled by the external trigger. When an external trigger is applied, one discharge signal (V_{sub}) is generated right after the active edge of the trigger. The exposure starts when the discharge signal is in the off state. The exposure is off following the trigger active off. Exposure time is controlled by the pulse width of the external trigger. Because the CCD requires some overhead from trigger active off to the transfer gate event, the actual exposure time is equal to:

$$\text{Exposure Time} = \text{Pulse Width} + 20.6\mu\text{s}$$

Since one discharge signal (V_{sub}) is generated right after the active edge of the trigger, it is asynchronous with LDV, and the discharge signal may happen during an active video transfer period, visible reset noise may show in the current image. To avoid reset noise, the maximum trigger frequency in PWC mode should be less than $1 / (\text{exposure time} + \text{one frame transferring time})$.

The minimum active period of the external trigger is $5\mu\text{s}$. Theoretically, the maximum active period of the external trigger is unlimited. But, since images obtained at 25°C are often very degraded due to thermal noise, it is recommended the active period of the external trigger be no longer than one second.

FIGURE 56. Pulse Width Control Trigger

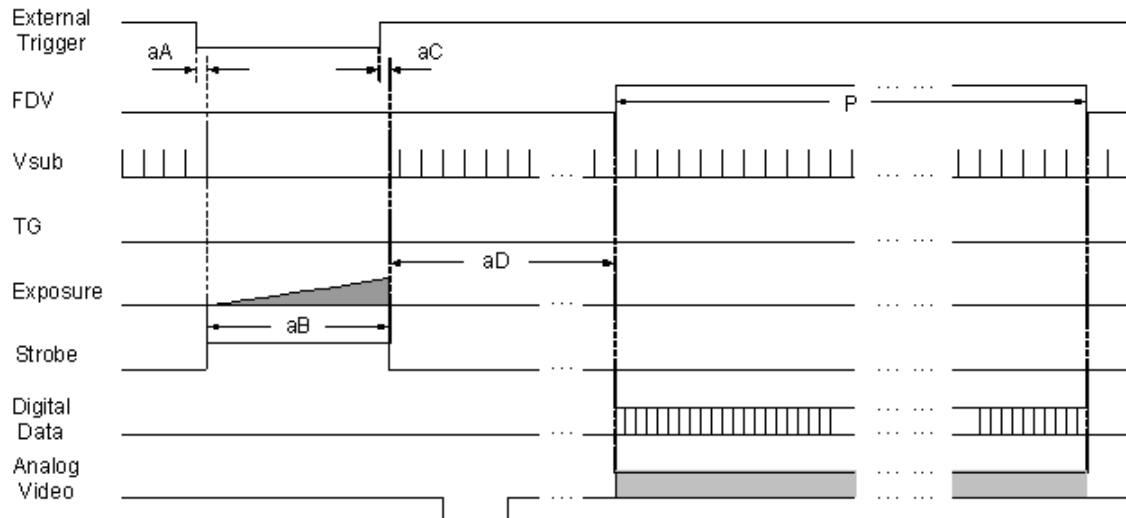

6.4.6 Particle Imaging Velocimetry Fixed Exposure Mode

In Particle Imaging Velocimetry (PIV) Fixed Exposure Mode, when an external trigger is applied, the first time exposure starts the same as PWC mode does. It lasts a very short period ($8\mu s$). The second time exposure starts during the transferring time of the first image accumulated in the first exposure time. The second time exposure continues until the first image transfers completely. The second image is transferred after the second exposure. There is a short period ($500ns$) between the first exposure and the second exposure. In order to keep two exposure periods constant, the LDV is reset before the first image is transferred out.

The maximum trigger frequency in this mode is equal to $1 / (\text{transfer time of two frames} + 4\mu s)$.
 The minimum active period of the external trigger is $5\mu s$

FIGURE 57. PIV Exposure Timing Table

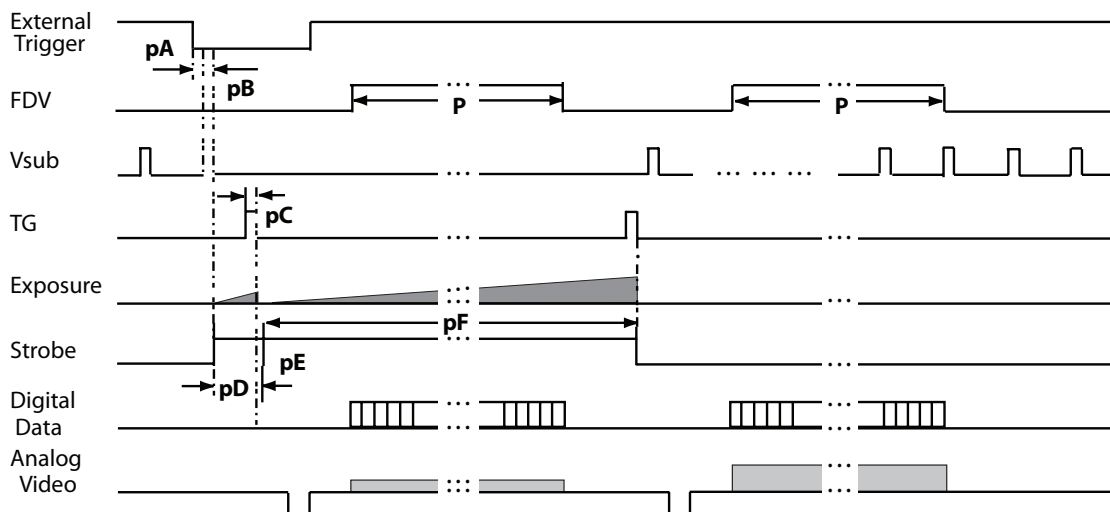

6.4.7 PWC PIV Mode

The PWC PIV is based on PIV Fixed Exposure. In this mode, the first time exposure is controlled by the pulse width of the external trigger, which is similar to PWC mode. The real exposure time of the first image is equal to the pulse width of the external trigger.

The maximum trigger frequency in this mode is equal to $1 / (\text{transfer time of two frames} + \text{exposure time of the first image})$.

The minimum active period of the external trigger is 10 pixel clocks (250ns)

FIGURE 58. PWC PIV Timing Table.

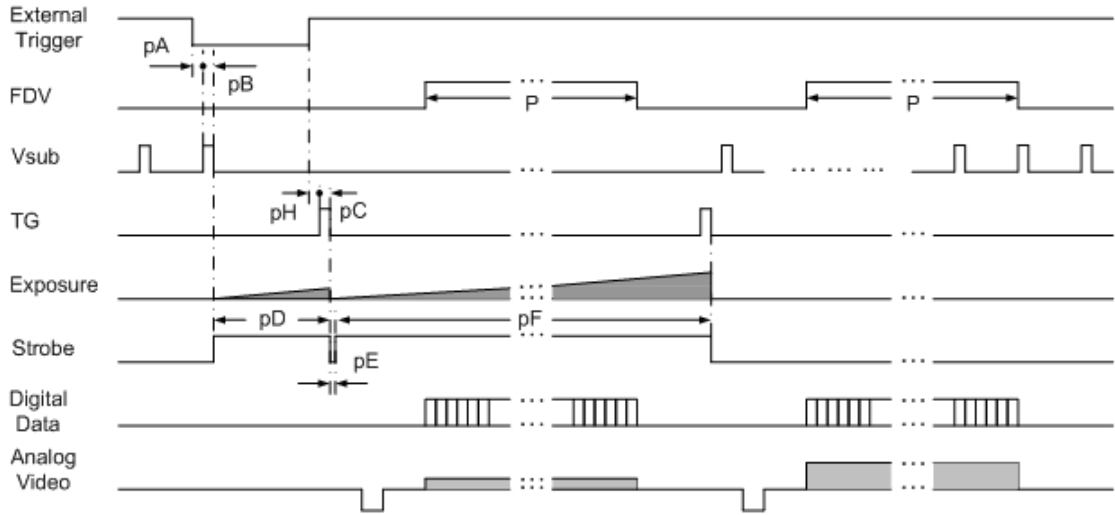

TABLE 5. Timing Chart

Timing		Scan Mode							Unit
		A	B	C	D	U	T	Z	
tA	dual	1300	1300	1300	1300	1300	728	1924	Unit
	single	2392	2393	2392	2393	2393	1274	3016	
tB	dual	1024	1024	1024	1024	1024	512	256	Pixel Clock
	single	2048	2048	2048	2048	2048	1024	512	
tC	dual	276	276	276	276	276	216	1668	
	single	344	344	344	344	344	250	2504	
tD	dual	176	176	176	176	176	166	800	
	single	176	176	176	176	176	166	800	
tE	dual	100	100	100	100	100	50	868	
	single	168	168	168	168	168	84	1704	
tF		80	80	80	80	80	40	80	
tG		224	224	224	224	224	112	224	

Timing		Scan Mode							Unit
		A	B	C	D	U	T	Z	
tH		A, B, C, D, U and Z: $n \cdot tA + 822$ (n=1, 2, 3, ...) T: $n \cdot tA + 411$ (n=1, 2, 3, ...)							Pixel Clock
tJ	dual	100	100	100	100	100	50	868	Video Line
	single	166	166	166	166	166	83	1702	
tK		100	100	100	100	100	50	100	
tL	dual	76	76	76	76	76	116	700	
	single	78	78	78	78	78	117	702	
tM		2048	2048	2048	2048	2048	1024	512	
tN		2080	1100	620	385		1040	650	
tP		2048	1000	500	250		1024	512	
tQ		32	100	120	135		16	138	
tR					tU-3				
tS					tW+6				
tT					tH				
tU	dual	16	50	58	61		8	x1: 67 x2: 46 x3: 25 x4: 4	
	single	16	50	58	61		8	x1: 44 x2: 30 x3: 17 x4: 4	
tV		3							
tW	dual	13	47	59	71		5	x1: 68 x2: 89 x3: 113 x4: 131	
	single							x1: 91 x2: 105 x3: 118 x4: 131	

TABLE 6. Asynchronous Mode Chart

	Async no Shutter	Async Preset and Prog. Shutter	PWC
aA	<1 line	<1 line	6 clk
aB	9.5 line	(n + 1) lines + 1024 clk	Pulse width + 1024 clk
aC			1024 clk

	PIV Fixed Expo	PIV PWC	Unit
pA	6	6	Pixel
pB	200	200	
pC	160	160	
pD	320	320	
pE	20	20	
pF	1	1	Frame

6.5 Dynamic Range Control

FIGURE 59. Output and Blooming

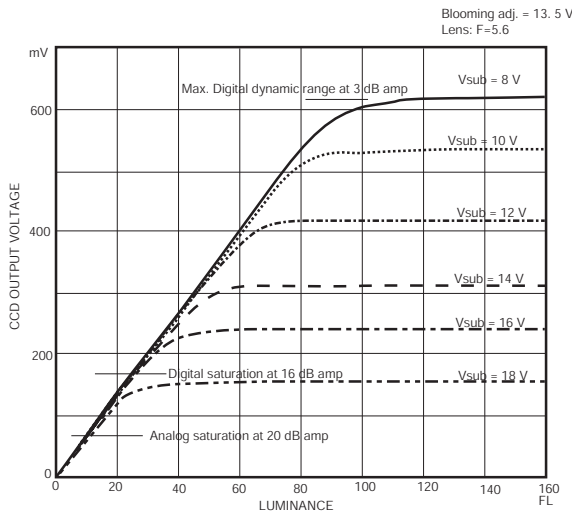

The typical interline transfer CCD has fixed noise levels based on dark current (thermal or KT noise), pattern noise, and the operating clock speed. In general, the level of the 20 MHz pixel clock CCD at room temperature is around 20 to 50 electrons. The maximum capacity of CCD charges is limited by the well capacity at saturation. The range is limited by the structure and the pixel size.

The TM-4200CL uses a CCD with 7.4 μm x 7.4 μm pixel and two-phase vertical shift register structure. The well capacity is 40,000 electrons. The theoretical dynamic range is 40,000:30 = 1333:1 (60 dB).

A typical CCD camera does not use the full dynamic range due to the nominal gain and the output specification such as RS-170. The typical CCD camera's gain is set at 16 to 22 dB and the RS-170 video level is 714 mV. Using 20 dB gain for the calculation, CCD output is limited to $714/10 = 71.4$ mV. Since the CCD's saturation voltage is 400 mV to 500 mV, it uses less than 1/5 of the full dynamic range.

Machine vision and outdoor applications, cannot afford to miss image information behind the saturation, which is why the dynamic range adaptation is critical.

6.5.1 Programmable Look-Up Table (LUT) and Knee Control

The TM-4200CL has a built-in LUT (look-up table) for dynamic range control.

At a specific gain setting, the offset (minimum level.... dark point) and A/D reference top voltage (maximum level... saturation point) are set to 12-bit A/D input so that the full dynamic range of the CCD is utilized at 12-bit references as the input and the LUT output is converted into either 8-bit or 10-bit to adjust the gamma correction. There is no 12-bit LUT.

The look-up table has two knee points (variable gamma selection) that allow the 10-bit input to be segmented into three regions. The look-up table selection can be made by knee curve direct input.

6.6 External Sync and Pixel Locking

The TM-4200CL accepts an external sync of standard HD and VD at TTL level for general locking to a system sync and clock. The frequency requirement is as follows:

Full Progressive Scan:

$$f_{HD} = 30.769 \text{ KHz} \pm 2\%$$

$$f_{VD} = 14.79 \text{ Hz} \pm 2\%$$

(Internal Master clock = 80.00 MHz,

Pixel clock = 40.00 MHz)

100L Partial Scan:

$$f_{HD} = 30.769 \text{ KHz} \pm 2\%$$

$$f_{VD} = 27.97 \text{ Hz} \pm 2\%$$

500L Partial Scan:

$$f_{HD} = 30.769 \text{ KHz} \pm 2\%$$

$$f_{VD} = 49.63 \text{ Hz} \pm 2\%$$

250L Partial Scan:

$$f_{HD} = 30.769 \text{ KHz} \pm 2\%$$

$$f_{VD} = 79.92 \text{ Hz} \pm 2\%$$

7 Serial Communication Kit

7.1 Serial Communication Kit

The Camera Link version's control software is included in the AccuPiXEL Camera Control software. For a detailed description of the software's operation, please see the software portion of this manual "Graphical User Interface" on page 7.

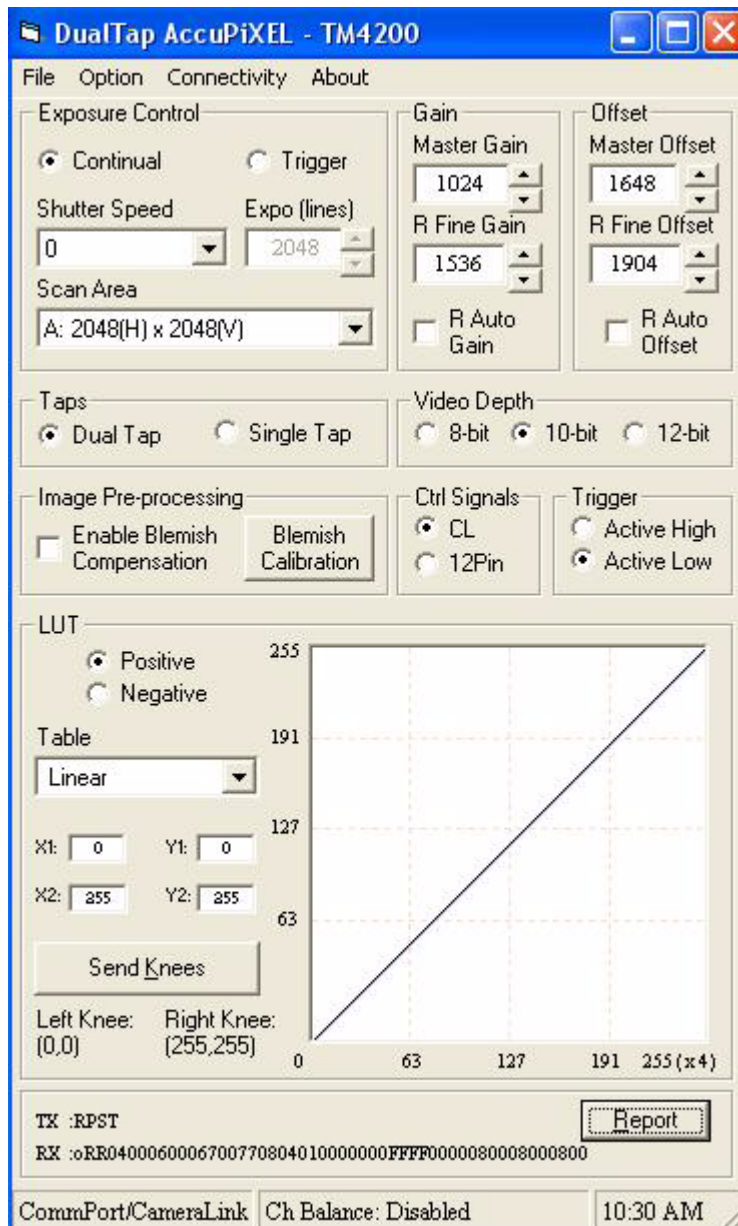

7.2 TM-4200CL Command List

The LVDS-version camera can be controlled via RS-232 commands. The Start character is always “:” and the End character is always “CR” (return). For example, to set Asynchronous Pulse Width Mode, send the command :SA9“CR” to the camera. The following table contains RS-232 commands that can be used to control the camera.

TABLE 7. TM-4200CL Command List

Command	Parameter	End of Cmd	Ack. Response	Description
Scan Mode				
:SMD	X	<cr>	:o<cr>	Set Preset Scan Area (X=A,B,C,D,T)
:SMDZ=	X	<cr>	:o<cr>	Set Digital Zoom (X=0,1,2,3)
:SMDU=	XXXXYYYY	<cr>	:o<cr>	Set Programmable Scan Area (XXXX=0000 - 07FF, YYYY=0001 - 0800)
:SMD?		<cr>	:oMD[X]<cr>	Inquire current scan mode (X=A,B,C,D,T,Z,U)
Shutter Mode and Shutter Speed				
:MSH=	X	<cr>	:o<cr>	Set Continuous Mode Preset Shutter (X= 0 - 9)
:DSH=	XXX	<cr>	:o<cr>	Set Continuous Mode Programmable Shutter (XXX=000 - total lines)
:ASH=	X	<cr>	:o<cr>	Set Async Mode Preset Shutter (X=0 - 9, A, B) (X=0 async no shutter, (X=1-8 Preset Shutter, X=9 PWC, X=A Fixed exposure PIV, X=B PWC PIV)
:ADS=	XXX	<cr>	:o<cr>	Set Async Mode Programmable Shutter (XXX=000 - 81F)
:SHR?		<cr>	:o[shtr]<cr>	Inquire current shutter mode
Gain and Offset				
:MGA=	XXX	<cr>	:o<cr>	Set Master Gain (XXX = 000 - FFF)
:MGB=	XXX	<cr>	:o<cr>	Set R channel Fine Gain (XXX = 000 - FFF)
:VRA=	XXX	<cr>	:o<cr>	Set Master Offset (XXX = 000 - FFF)

Command	Parameter	End of Cmd	Ack. Response	Description
Gain and Offset Continued				
:VRB=	XXX	<cr>	:o<cr>	Set R channel Fine Offset (XXX = 000 - FFF)
:MGA?		<cr>	:oMG[XXX]<cr>	Inquire Master Gain (XXX = 000 - FFF)
:MGB?		<cr>	:oSG[XXX]<cr>	Inquire R channel Fine Gain (XXX = 000 - FFF)
:VRA?		<cr>	:oMF[XXX]<cr>	Inquire Master Offset (XXX = 000 - FFF)
:VRB?		<cr>	:oSF[XXX]<cr>	Inquire R channel Fine Offset (XXX = 000 - FFF)
Lookup Table				
:LINR		<cr>	:o<cr>	Set linear table
:GM45		<cr>	:o<cr>	Set gamma .45 table
:KNEE=	X1Y1X2Y2	<cr>	:o<cr>	Set knees (X1, Y1, X2, Y2 = 00 - FF)
:NLUT	X	<cr>	:o<cr>	Set Positive Knee or Negative Knee (X = 0 Positive, X = 1 Negative)
:LUT?		<cr>	:o[lut]<cr>	Inquire current LUT setting
Channel Balance				
:EABL		<cr>	:oAB0<cr>	Enable Gain Balancing
:DABL		<cr>	:o<cr>	Disable Gain Balancing
:ABL?		<cr>	:oAB[X]<cr>	Check Gain Balancing Status (X = 1 Enable, X = 0 Disable)
:ACL=	X	<cr>	:o[AC][X]<cr>	Enable/Disable Optical Black Balancing and Inquire Status (X = 0 Disable, X = 1 Enable, X = ? Inquire Status)
Vsub				
:DCI=	XXX	<cr>	:o<cr>	Set Vsub (XXX = 600 - D00)
:DCI?		<cr>	:oDC[XXX]<cr>	Inquire Vsub (XXX = 600 - D00)

Command	Parameter	End of Cmd	Ack. Response	Description
EEPROM				
:WRPG	X	<cr>	:o<cr>	Write Page (X = 0 - 6) (Unlock the Password first if writing to page 0) (Page 0 is the factory default setting, Page 1 is the power up default setting)
:LDPG	X	<cr>	:o<cr>	Load Page (X = 0 - 6)
:RDPG	X	<cr>	:o[settings]<cr>	Read Page (X = 0 - 6)
:RPST		<cr>	:o[settings]<cr>	Report Current Settings
Dual Tap Digital Video Output Order				
:VDO	X	<cr>	:o[VD][X]<cr>	Set Dual Tap Digital Video Output Order (X = A, B, C, ?) (A <--<--, B <---->, C <----->, ? Inquire video output order)
Image Pre-processing				
:BLC=	0	<cr>	:o<cr>	Set White Blemish Calibration Flag
:EBL=	X	<cr>	:o[BL][X]<cr>	Enable/Disable Blemish Compensation and Inquire Status (X = 0 Disable, X = 1 Enable, X = ? Inquire Status)
Miscellaneous				
:DUL=	X	<cr>	:o<cr>	Single Tap/Dual Tap Selection (X = 0 Dual Tap, X = 1 Single Tap)
:DDP=	X	<cr>	:o<cr>	Set Output Data Depth (X = 0 8-bit, X = 1 10-bit, x = 2 12-bit)
:CCS=	X	<cr>	:o<cr>	Select Camera Control signals (X = 0 CL Conn, X = 1 Hirose Conn)
:TAH=	X	<cr>	:o<cr>	External Trigger Polarity (X = 1 Active High, X = 0 Active Low)
:TPN	X	<cr>	:o<cr>	Enable/Disable Test Pattern (X = 1 Enable, X = 0 Disable)
:CAM?		<cr>	:o[model]<cr>	Inquire Camera Model
:VER?		<cr>	:o[version]<cr>	Inquire MPU firmware version

Command	Parameter	End of Cmd	Ack. Response	Description
:SGE=	X	<cr>	:o<cr>	Set Digital Output Interface (X = 0 CameraLink, X = 1 GigE)
:CCD=	X	<cr>	:o<cr>	CCD information (X = 1)
:PuLX	X	<cr>	:o<cr>	Password (X = 1 Administrator, X = 0 Users)
Note: If a command is not accepted for any reason, the camera will return a “nack” response. “:e” <cr> *Not available yet.				

TABLE 8. TM-4200CL Command Response Table

Command	Parameter	End of Cmd	Description
Byte 1, 2	Master Gain		Master Gain (H'0000 - H'0FFF: -3dB - +12dB)
Byte 3, 4	R Channel Fine Gain		R Channel Fine Gain (H'0000 - H'0FFF)
Byte 5, 6	Master Offset		Master Offset (H'0000 - H'0FFF)
Byte 7, 8	R Channel Fine Offset		R Channel Fine Offset (H'0000 - H'0FFF)
Byte 9	Function Flag 0		
	Bit 0	Scan Area 0	0000=2048x2048 0001=2048x1000 0010=2048x500 0011=2048x250
	Bit 1	Scan Area 1	0100=2x2 binning of 2048x2048 1111=User Programmable Scan Area
	Bit 2	Scan Area 2	1000=Digital Zoom x1 1001=Digital Zoom x2
	Bit 3	Scan Area 3	1000=Digital Zoom x3 1001=Digital Zoom x4
	Bit 4	Rsvd	
	Bit 5	Rsvd	
	Bit 6	Pixel Output Order 0	00=<----<---- 01=<=<----->
	Bit 7	Pixel Output Order 1	10=<=<-----
Byte 10	Function Flag 1		
	Bit 0	Shutter 0	Continuous Mode: 0000 - 1001=Continuous pre-set shutter 0 - 9

Command	Parameter	End of Cmd	Description
Byte 10	Bit 1	Shutter 1	Trigger Mode:
	Bit 2	Shutter 2	0000=Async no shutter 0001 - 1000=Async preset shutters 1-8
	Bit 3	Shutter 3	1001=PWC 1010=PIV Fixed Exposure 1011=PIV PWC
	Bit 4	Shutter Mode 0	00=Continuous Preset Shutter 01=Trigger Preset Shutter
	Bit 5	Shutter Mode 1	10=Trigger Programmable Shutter 11=Continuous Programmable Shutter
	Bit 6	Data Depth 0	00=8bit 01=10bit
	Bit 7	Data Depth 1	10=12bit
Byte 11	Function Flag 2		
	Bit 0	Look-up table 0	00=Linear 01=Gamma.45
	Bit 1	Look-up table 1	10=User Knee Table
	Bit 2	Rsvd	
	Bit 3	Camera Control Signals	0=CameraLink Connector 1=Hirose 12pin Connector
	Bit 4	Rsvd	
	Bit 5	Trigger Signal Polarity	0=Active Low 1=Active High
	Bit 6	Dual / Signal Tap	0=Dual Tap 1=Single Tap
	Bit 7	Positive / Negative LUT	0=Positive LUT 1=Negative LUT
Byte 12	Function Flag 3		
	Bit 0	R Channel Auto Fine Gain	0=Disable 1=Enable
	Bit 1	R Channel Auto Fine Offset	0=Disable 1=Enable
	Bit 2	Rsvd	
	Bit 3	Rsvd	
	Bit 4	Blemish Compensation	0=Disable 1=Enable
	Bit 5	Rsvd	

Command	Parameter	End of Cmd	Description
Byte 12	Bit 6	Password	0=Disable 1=Enable
	Bit 7	Test Pattern	0=Disable 1=Enable
Byte 13, 14	(X1, Y1)		Coordinate for Knee 1 (X1, Y1=H'00 - H'FF)
Byte 15, 16	(X2, Y2)		Coordinate for Knee 2 (X2, Y2=H'00 - H'FF)
Byte 17, 18	Start Line of Programmable Scan Area		Start Line of Programmable Scan Area (H'0000 - H'07FF)
Byte 19, 20	Total Lines of Programmable Scan Area		Total Lines of Programmable Scan Area (H'0001 - H'0800)
Byte 21, 22	Shutter Speed of Programmable Shutter		Shutter Speed of Programmable Shutter (H'0000 - H'081F)
Byte 23, 24	Vsub Voltage		Vsub Voltage (H'0600 - H'0D00=7.8V - 17V)

8 Problems and Solutions

Following are troubleshooting tips for common problems. In general, problems can easily be solved by following these instructions. If the following remedies fail to offer a solution to your problems, please contact a JAI representative.

8.0.1 Symptom: No Video

Remedies: Check that the following are properly connected and operational.

- Power supplies
- Power cables
- Main power source
- Shutter control
- Async mode
- Lens
- Digital output cable
- Analog video cable

8.0.2 Symptom: Dark Video

Remedies: Check that the following are properly connected and operational.

- Shutter selection
- Iris opening on the lens

8.0.3 Symptom: Non-synchronized Video

Remedies: Check that the following are properly connected and operational.

- Proper mode output
- Frame grabber software camera selection

8.1 Information and Support Resources

For further information and support:

Phone: (408) 383-0300
(800) 445-5444
Fax: (408) 383-0301
E-mail: imaging@pulnix.com
Mail: JAI PULNiX, Inc.
Sales Department
625 River Oaks Pkwy.
San Jose, CA 95134
ATTN: Video Applications
Web Site: www.jaipulnix.com

9 Appendix

9.1 Specifications

TABLE 9. TM-4200CL Camera Specifications Table

Feature	TM-4200CL
Imager	1.2" progressive scan interline transfer CCD
Active Area	15.15mm x 15.15mm
Active Pixels	2048 (H) x 2048 (V)
Cell Size	7.4µm x 7.4µm
Display Mode (Active Pixels)	<p>A 2048 (H) x 2048 (V) @ 15 Hz</p> <p>B 2048 (H) x 1000 (V) @ 28Hz (partial scan)</p> <p>C 2048 (H) x 500 (V) @ 50Hz (partial scan)</p> <p>D 2048 (H) x 250 (V) @ 80Hz (partial scan)</p> <p>U User-programmable partial scan</p>
Sync	<p>Internal/External auto switch</p> <p>HD/VD, 4.0 Vp-p impedance 4.7K Ω</p> <p>VD=14.79 Hz ± 2%, non-interlace</p> <p>HD=30.78 kHz ± 2%</p>
Data Clock Output	40.00 MHz
Resolution	Digital: 2048 (H) x 2048 (V), (Analog: over 800 TV lines (H) x 1600 TV lines (V))
S/N Ratio	56dB
Min. Illumination	Monochrome 0.25 lux. Color: 2.6 lux. f = 1.4 (no shutter) @ 15 fps. Sensitivity: 31µV/e-
Video Output	Analog: 714 mVp-p composite video, 75 Ω Digital output: 12-bit /10-bit/8-bit single tap/dual tap
AGC	OFF
Gamma	Programmable LUT (Gamma 1.0 std.)
Lens Mount	C, F, M 42 mount (use >1" format lenses)
Power Requirement	12V DC, ± 10%, 520 mA ± 20mA (typical at 25°)
Operating Temp.	-10°C to 50°C*
Vibration	7 Grms (10Hz to 2000Hz) Random
Shock	70G, 11 ms, half-sine
Size (W x H x L)	51mm x 51mm x 74mm
Weight	191 grams, 6.7 oz. (without tripod)
Optional Functions	Internal IR Filter Added (OP3-1); Optical Filter Removal (OP3-2); Glassless CCD Imager (OP21); Glassless UV CCD Imager (OP21-UV)
Optional Accessories	
I/O	26CL-02-26 (2m), 26CL-05-26 (5m)
CL cable	
Power Cable	12P-02S
Power Supply	PD-12UUP series (includes power connector)

*. Refer to Section 5.2.1 on page 22 for information on camera heat dissipation. Image quality will degrade with increasing temperature.

9.1.1 TM-4200CL Physical Dimensions

FIGURE 60. Physical Dimensions

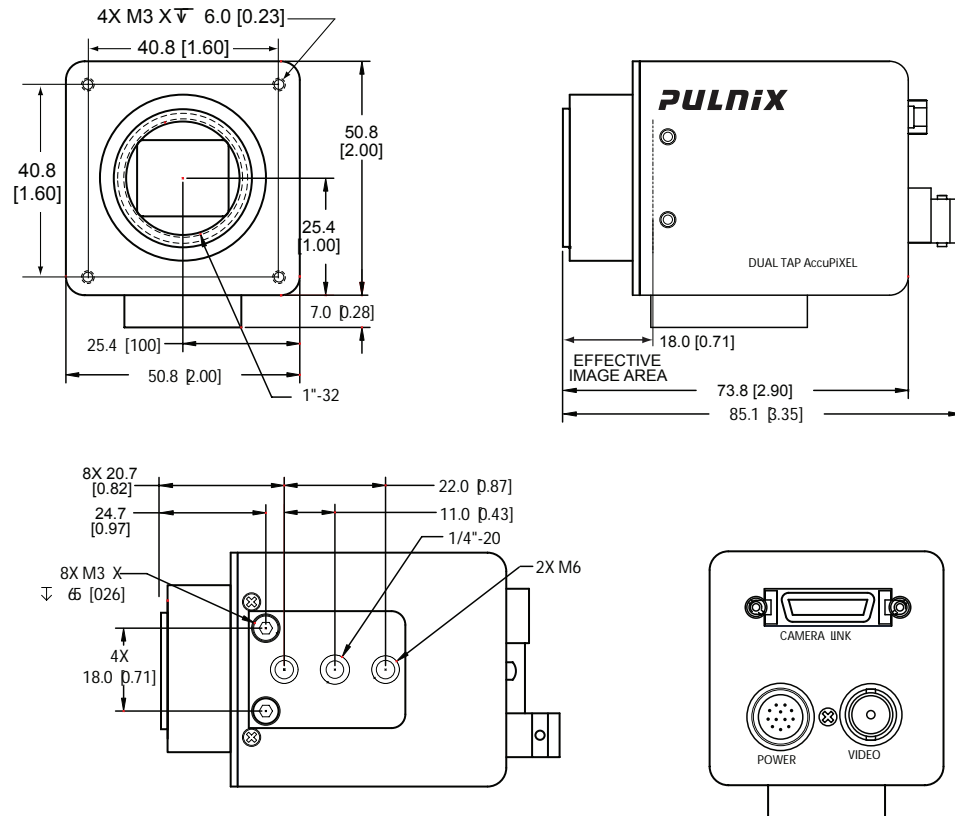

9.1.2 Spectral Response

FIGURE 61. Spectral Response

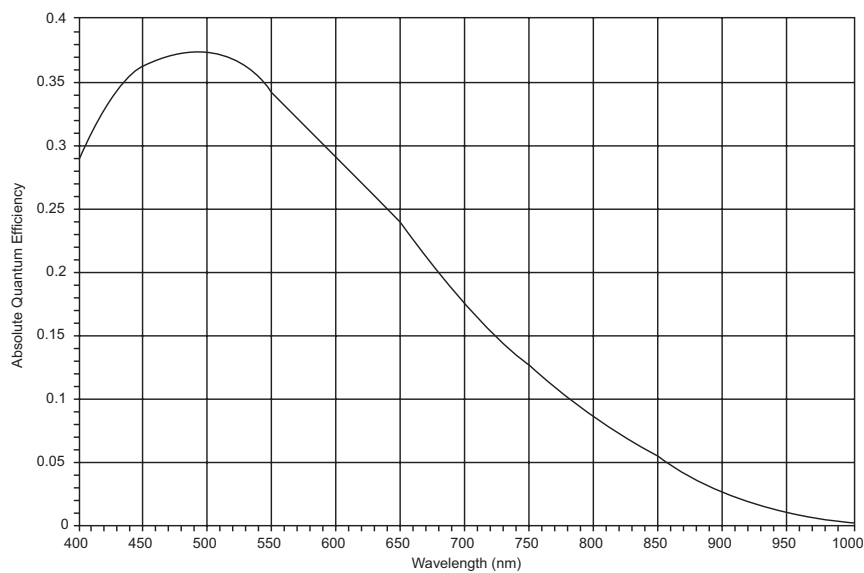



Imaging Products

JAI PULNiX, Inc. Tel: 408-383-0300
625 River Oaks Pkwy. Tel: 800-445-5444
San Jose, CA 95134 Fax: 408-383-0301

Email: imaging@jaipulnix.com

www.jaipulnix.com

